

MERIT BADGE SERIES

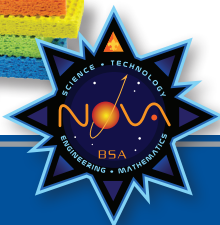

AUTOMOTIVE MAINTENANCE

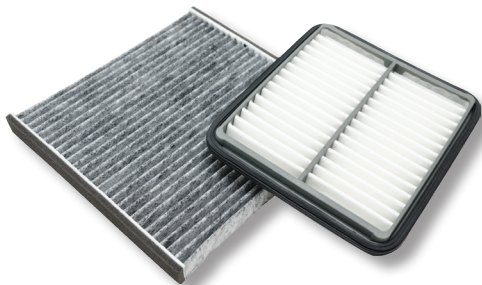

SCOUTING AMERICA
MERIT BADGE SERIES

AUTOMOTIVE MAINTENANCE



"Enhancing our youths' competitive edge through merit badges"

Scouting  America.

You will need access to a car or truck and its owner's manual to meet some requirements for this merit badge. If you do not have your own vehicle, you should work with your counselor or other trusted adult to obtain access to a vehicle and the owner's manual for that vehicle.

Requirements

Always check [scouting.org](https://www.scouting.org) for the latest requirements.

1. **Safety and Registration.** Do the following:
 - (a) Explain to your counselor the hazards you are most likely to encounter during automotive maintenance activities, and what you should do to anticipate, help prevent, mitigate, or lessen these hazards.
 - (b) Discuss with your counselor the safety equipment, tools, and clothing used while checking or repairing a motor vehicle. Use this equipment, tools, and/or clothing (when needed or called for) in meeting the requirements for this merit badge.
 - (c) Explain the different types of motors you may encounter.
 - (d) Explain the safety considerations when performing maintenance on a vehicle equipped with a high-voltage electrical system.
 - (e) Review the maintenance chart in the vehicle owner's manual. Explain the requirements and time limits.
 - (f) Explain the purpose, importance, and limitations of safety belts and passive restraints.

- (g) Find out the requirements for your state's emissions and safety inspections (as applicable), including how often a vehicle needs to be inspected.
 - (h) Explain the importance of registering a vehicle and find out the annual registration fee for renewing your family car's registration.
2. **General Maintenance.** Do the following:
- (a) Demonstrate how to check the following:
 - (1) Brake fluid
 - (2) Engine oil
 - (3) Coolant
 - (4) Power steering fluid
 - (5) Windshield washer fluid
 - (6) Transmission fluid
 - (7) Battery fluid (if possible) and condition of the battery terminals
 - (b) Locate the fuse boxes; determine the type and size of fuses. Demonstrate the proper replacement of burned-out fuses.
 - (c) Demonstrate how to check the condition and tension of belts and hoses.
 - (d) Check the vehicle for proper operation of its lights, including the interior overhead lights, instrument lights, warning lights, and exterior bulbs.
 - (e) Locate and check the air filter(s).
3. **Dashboard/Driver Information Center.** Do the following:
- (a) Explain the function of the fuel gauge, speedometer, tachometer, oil pressure, and engine temperature gauge. Point each one out on the instrument cluster.
 - (b) Explain the symbols that light up on the dashboard and the difference between the yellow and red symbols. Explain each of the indicators on the dashboard, using the owner's manual if necessary.
 - (c) Explain the messages and alerts that may be displayed on the dashboard/driver information center including maintenance-related reminders.

4. **Tires.** Do the following:
 - (a) Explain the difference between tire manufacturer's and vehicle manufacturer's specifications and show where to find them.
 - (b) Demonstrate how to check tire pressure and properly inflate a tire. Check the spare tire and make sure it is ready for use.
 - (c) Explain why wheel alignment is important to the life of a tire. Explain caster, camber, and toe-in adjustments on wheel alignment.
 - (d) Explain the purpose of the lateral-wear bar indicator.
 - (e) Explain how to dispose of old tires in accordance with local laws and regulations.
5. **Engine.** Do the following:
 - (a) Explain how an internal combustion engine operates. Tell the differences between gasoline and diesel engines. Explain how a gasoline-electric hybrid vehicle is powered.
 - (b) Discuss the purpose of engine oil. Explain the API service code, the SAE number, and the viscosity rating.
 - (c) Explain where to find the recommended oil type and the amount of oil to be used in the vehicle engine.
6. **Cooling System.** Do the following:
 - (a) Explain the need for coolant in the cooling system, and the importance of selecting the correct coolant type for a given vehicle.
 - (b) Explain how to flush and change the engine coolant in the vehicle, and how to properly dispose of the used coolant.
7. **Fuel System.** Do the following:
 - (a) Explain how the air and fuel systems work together and why it is necessary to have an air filter and fuel filter.
 - (b) Explain how a fuel injection system works and how an onboard computer works with the fuel injection system.

8. Ignition and Electrical Systems. Do the following:

- (a) Diagram and explain the parts of one of the following electrical systems:
 - (1) Starting/charging system
 - (2) Hybrid or electric vehicle inverter
 - (3) Lighting system
- (b) Explain the engine's firing order.
- (c) Explain the purpose of the spark gap.
- (d) Demonstrate how to safely connect jumper cables to your car battery.
- (e) Discuss with your counselor what factors can affect range on an electrified vehicle. Explain the procedure for recharging an electric or plug-in hybrid vehicle.
- (f) Explain what other vehicle systems are dependent on a reliable electrical system.

9. Drive Train. Do the following:

- (a) Diagram the drive train and explain the different parts.
- (b) Explain the difference between automatic and standard transmissions.
- (c) Explain the types of automatic transmission fluid.
- (d) Explain the types of lubricants used in a standard transmission, and in the differential and transfer case.
- (e) Explain the difference between front-wheel, rear-wheel, and four-wheel drive.



10. **Brake System.** Do the following:
 - (a) Explain the brake system (including antilock systems) and how it operates.
 - (b) Explain the differences between disc and drum systems.
 - (c) Demonstrate how to check the condition of a vehicle's brake system. After checking, make recommendations for repairs (if necessary).
11. Do TWO of the following:
 - (a) Determine the value of three different vehicles you are interested in purchasing. One must be new and one must be used; the third vehicle can be new or used. For each vehicle, find out the requirements and cost of automobile insurance to include basic liability and options for collision, comprehensive, towing, and rental car. Using the three vehicles you chose and with your counselor's assistance, complete the operation/maintenance chart provided in this pamphlet. Use this information to determine the operating cost per mile for each vehicle, and discuss what you learn with your counselor.
 - (b) Choose a car cleaner and wax product for a vehicle you want to clean. Explain clear-coat paint and the precautions necessary for care. Clean the vehicle, both inside and out, and wax the exterior. Use a vinyl and rubber protectant (on vinyl tops, rubber door seals, sidewalls, etc.) and explain the importance of this protectant.
 - (c) Locate the manufacturer's jack. Use the jack to demonstrate how to engage the jack correctly on the vehicle, then change a tire correctly.
 - (d) Perform an oil filter and oil change on a vehicle. Explain how to properly dispose of the used oil and filter.
12. Find out about three career opportunities in the automotive industry. Pick one and find out the education, training, and experience required for this profession. Discuss this with your counselor, and explain why this profession might interest you.

Contents

That Marvelous Driving Machine	9
Maintenance, Registration, and Inspection	12
Vehicle Safety	20
Advanced Driver Assistance Systems (ADAS)	24
The Engine	26
The Drive Train	34
Wheels and Tires.	38
The Braking System.	46
The Air Intake and Fuel Systems	50
The Lubrication System	58
The Cooling System.	62
The Ignition and Electrical Systems	68
The Computer and Emission Control Systems	81
The Dashboard	84
Buying a Car	90
Careers in Automotive Maintenance	96
Automotive Maintenance Resources	98



That Marvelous Driving Machine

On June 4, 1896, Henry Ford took a short drive around his Detroit neighborhood on his experimental quadricycle. This vehicle was little more than a frame, a seat, a small engine, a steering bar, and four bicycle wheels. With its 4-horsepower engine, the quadricycle could reach a top speed of 20 miles per hour. By comparison, even the most basic cars today have 100-horsepower engines and can easily reach speeds of 100 miles per hour.

Automobile Systems

Modern automobiles are complex machines. They are assembled from more than 15,000 parts, with more than 1,500 synchronized to move together. Learning how they work may appear impossible. In fact, just the opposite is true. The trick is to divide car operation into several systems. We will explain and describe each system individually, how these systems relate to each other, and the total operation of the car. Let's begin with the engine.

In technical terms, 1 horsepower equals the power a horse would use to move 550 pounds of cargo a distance of 1 foot in 1 second. That's 745.7 watts of power.





Cars have come a long way since Henry Ford's first horseless carriage, shown along with the 10 millionth model off the production line. Some of today's modern cars will do the navigating—or even the parking!—for you.

By 1909, these inventors had been so successful that *Scientific American* magazine said, “The automobile has practically reached the limit of its development [because] during the past year no improvements of a radical nature have been introduced.”

Since then, of course, many radical improvements have been introduced, including automatic transmissions, cruise control, turn signals, seat belts, in-dash radios, onboard navigation systems, steering and ride control, collision avoidance, and self-diagnostics. Today's cars go faster, last longer, and work better than Ford could ever have imagined.

However, if you strip away all the safety features and creature comforts from modern cars, you will find something a lot like the Model Ts of a hundred years ago. If you look behind the wheel, you will find people who long to go places their feet can't take them—just like their great-great-grandparents did.

A System of Systems

Modern automobiles are complex machines; the typical car has some 15,000 parts. It might seem impossible to understand how cars work, but just the opposite is true. The trick is to divide the car into several systems: the engine, the drive train, the lubrication system, etc. By learning how each system works by itself and with other systems, you can understand how the whole car functions.

First, though, we will look at some important information about maintenance, registration, and safety, before moving on to the automobile's major systems.

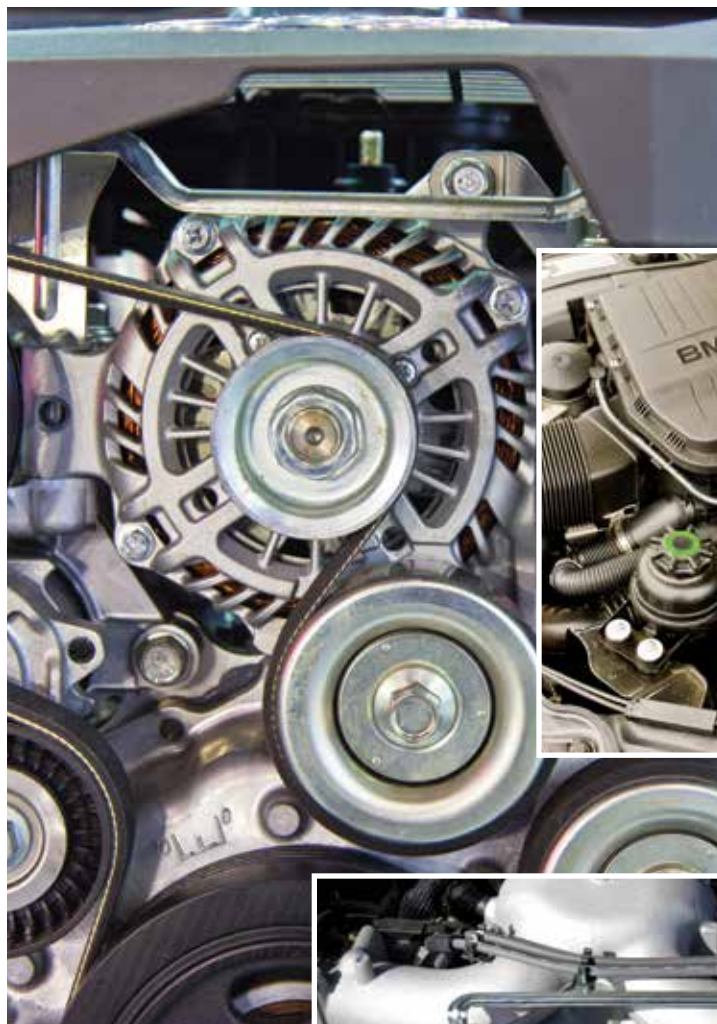



Maintenance, Registration, and Inspection

You probably have heard the old saying that an ounce of prevention is worth a pound of cure. Routine auto maintenance can prevent a lot of costly problems, some of which could damage the vehicle and even endanger the driver and passengers. By properly maintaining a vehicle, you can spot problems as they develop and extend the vehicle's life by many years.

Some maintenance tasks must be done by a dealership or other qualified service outlet. You can do others in your own garage or driveway—or even at the gas pump while you are filling the tank.

Scheduled Maintenance

The owner's manual that comes with every new car includes a section that describes when scheduled maintenance and other services should occur. Each manual provides one schedule for vehicles that rarely perform heavy-duty service and another schedule for vehicles that are heavily used, including vehicles that are driven mostly on short trips or in dusty conditions, vehicles that idle often for long periods, and vehicles that pull trailers.

A new car's warranty covers the cost of repairs if problems occur during a specified period. (This period is normally at least 12 months but can be as long as 10 years for some parts). However, the warranty is valid only if the car's owner follows the recommended maintenance schedule. It is a good idea to keep detailed records of all maintenance done on a car.

Prevention goes hand in hand with mitigation, which means “to lessen in force or intensity” and “to make less severe.” By taking precautions to manage risk and the possibility of injury, you can be prepared to anticipate, help prevent, mitigate, and respond to just about any incident that might happen during automotive maintenance activities.

Each chart lists the items that require service at certain mileage or time intervals. For example, Schedule 1 might recommend that you change the engine oil every three months or 3,000 miles (whichever comes first), while Schedule 2 might recommend that you change the oil every 12 months or 7,500 miles.

Routine Maintenance

In between scheduled maintenance visits that require more specialized service, you can take care of many maintenance tasks yourself, many of which will be explained later in this pamphlet. For now, here is a quick list of tasks you should do regularly.

Look Under the Hood

Opening the hood on most cars is a three-step process. First, after putting the car in “park” and applying the parking brake, pull the hood-release handle inside the car. It is probably near the driver’s seat or under the dashboard. Second, find and release the latch under the front edge of the hood. You may have to check your owner’s manual for the location. Lastly, hold the hood up with one hand and use the other hand to raise the hood support rod into place. (Some hoods stay up by themselves using springs or hydraulic cylinders.) Be sure the support rod is securely placed in the proper grommet or slot so the hood won’t fall on you.





Windshield-washer fluid goes in a reservoir beneath a cap displaying a windshield wiper icon. The fluid includes detergent to clean the windshield and antifreeze to keep it from freezing in cold weather.



Wear eye and hand protection when cleaning a car's battery terminals. Battery acid is corrosive and extremely dangerous for eyes and skin. Rubber or nitrile gloves are recommended.

Weekly Maintenance

Take time about once a week to do the following:

- Check the levels of oil, coolant, and windshield-washer fluid. Top off the fluids if necessary.
- Visually inspect the tires for damage and excessive tread wear. Use a tire pressure gauge to check for proper inflation. Add air if necessary.
- Visually inspect the wiper blades for damage.
- Check the battery terminals for corrosion. If there is corrosion, you will see a gray or white powder on the terminals. Make sure the connections are tight.

Battery Tips

In many new cars, the battery powers such computer programming as the radio, clock, remote locks, and even wireless communication capabilities. If the battery power is cut off to these functions, it could mean expensive reprogramming by the car dealership. Check the owner's manual before disconnecting the battery for cleaning.



Checking the power steering fluid indicator and add power steering fluid if it shows “low.”

Monthly Maintenance

Every month or so, add the following to the weekly maintenance steps:

- Check the levels of transmission fluid, brake fluid, and power-steering fluid.
- If the battery is not sealed, check its water level. (Most batteries are sealed, but some older models might require this step.) Refill it with distilled water if necessary.
- Inspect the spark-plug wires, other electrical connections, hoses, and belts for damage and looseness.
- Wipe down door, trunk, and hood hinges. Apply white grease lubricant.
- Wash the exterior and vacuum the interior. Apply a commercial protectant to rubber, leather, and plastic surfaces such as vinyl tops, rubber door seals, and tire sidewalls.

Belts and hoses that need to be replaced might feel brittle or mushy when you pinch them; they also might show cracks. To accurately check the tension of belts, you must use a belt tension gauge. However, you can get a rough idea of tension by depressing the belt in the middle of its longest straight section. The belt should move approximately $\frac{1}{2}$ inch. Modern serpentine belts do not show obvious wear; use a manufacturer-approved wear gauge to determine if replacement is needed.



Maintaining the Car's Appearance

While keeping the engine and other internal systems is vital in extending the life of a car, don't forget to maintain the car's outside and interior, too.

Most older-model cars were painted with a *clear-coat finish* that protects the metal or fiberglass car body and provides an attractive shine. Clear-coat colors also are easily matched if one panel of the car must be replaced after an accident. Cleaning is a snap, too. If you use a commercial car wash product, follow the instructions on the bottle and be sure to use plenty of water to rinse the car completely. When washing a vehicle, change the water often to avoid scratching the vehicle finish with dirt caught in the sponge or mitt. Use a soft chamois to remove rinse water and to avoid spotting of windows, mirrors, and paint finish. Follow the wash with a good exterior wax. Carefully follow the instructions on the container to achieve the best results.

Maintaining the inside of the vehicle is easy as well. Use a soft cloth along with a commercial interior protectant to keep the dashboard and other interior features looking like new and protected from the extreme temperature changes in the summer and winter.



Texas is among the many states that utilize the “two steps, one sticker” process for vehicle registration renewal. The

vehicle must first pass inspection. Then the driver can renew the vehicle registration for a combined registration and inspection sticker to be displayed in the vehicle window. The state adopted this policy to help eliminate inspection sticker fraud and theft. Since the inspection is now required, drivers will also need to comply with state laws regarding vehicle safety and emissions testing. At least in Texas, this means more cars on the road are safer and environmentally friendly.

Vehicle Registration and Inspection

Every state requires a vehicle’s owner to register the vehicle before driving it on public streets. This process helps to ensure that the vehicle meets basic emissions and safety requirements, that the owner has liability insurance, and that the state knows who owns and operates the vehicle. The vehicle’s owner must pay a fee, as well as a property tax, to register the vehicle and receive license plates.

Many states require annual vehicle inspections. Some inspections check for safety problems like defective brakes and burned-out headlights. Others include testing for excessive tail-pipe emissions. In these states, vehicles must pass inspection in order to be registered.

To learn about the laws that apply in your state, check your state’s website or look in the state government listings in your phone book under “Department of Motor Vehicles” or “Vehicle Registration.” Make sure you have your parent or guardian’s permission first.



Vehicle Safety

Cars and trucks can weigh up to 2 tons. They travel down the highway at speeds of 65 miles per hour or more. Often only a few feet separate moving vehicles. Therefore, vehicle safety is very important. Modern cars use both active and passive safety features to help protect their occupants.

Active Restraints

Safety belts and child restraints are called *active restraints* because you must do something, such as buckling them, to make them work. When you use these features, you greatly increase your chances of surviving an accident.

Passengers travel at the same speed as the car. If the car suddenly stops (such as when it hits another object), they will keep traveling at the original speed until something stops them. That could be the windshield, the dashboard, the road—or a safety belt.

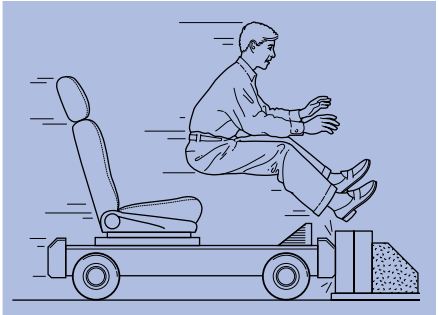
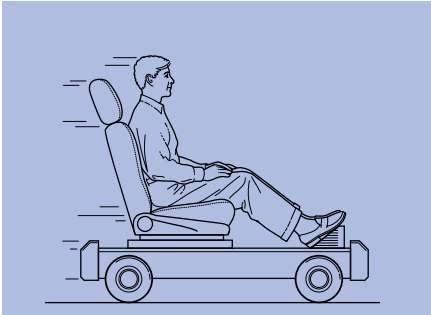

Why are safety belts necessary? Take this example: A man is riding a simple vehicle at any speed, and the vehicle stops suddenly. The rider does not stop until he hits another object. Had a safety belt been in place, the rider would have stopped while still in the seat.

If you are wearing a safety belt, you will slow down when the vehicle does. You will have more time to stop, you will stop over a longer distance, and your strongest bones—not the bones in your face—will absorb the force. That is why wearing safety belts makes such good sense.

Safety Belts

Most safety belts have two parts: a *seat belt* that goes across your lap and a *shoulder belt* that goes over your shoulder. Nearly all states require the driver and passengers to be buckled in at all times.

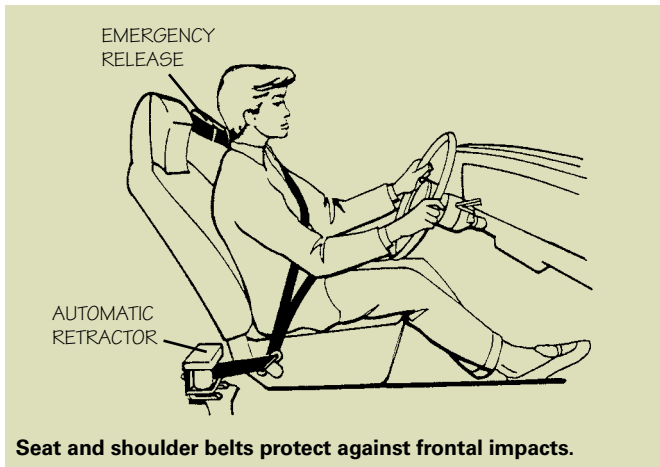

Some cars have automatic shoulder belts. You must still buckle the seat belt to be safe. Never rely on the shoulder belt by itself.

Be sure to install infant and child car seats securely and according to the manufacturer's instruction.

Child Car Seats

Have you ever seen someone holding a baby while riding in a car? Think about this: In a crash at 25 miles per hour, a 12-pound baby would become a 240-pound force, almost impossible to hold on to. Fortunately, all 50 states require that babies ride in infant restraints.



To learn more about car seat safety laws, with your parent or guardian's permission, find the website for your state's public safety department.



Some cars also include side-impact air bags, which open if the car is hit from either side.

Passive Restraints

All cars built today offer *passive restraints*. These are safety features that do not need the driver or passenger to do anything to make them work. The most common passive restraints are *air bags*. These devices stay in the steering wheel and dashboard until needed. They protect the driver and front-seat passenger. Air bags are required on all new passenger vehicles sold in the United States.

Here is how an air bag works. If a front-end crash occurs, sensors in the air bags notice that the car has suddenly slowed down or even stopped (a process called *deceleration*). This triggers a chemical reaction that fills the air bags with gas. In less than 1/20 of a second, the air bags balloon out, cushioning the driver and passenger.

It is important to remember that air bags are *supplemental restraints*; they are designed to work with—not instead of—safety belts.

Because air bags can open with lots of force, infants and children under age 13 should always ride in the back seat.



Air bags deploy automatically when a frontal crash occurs.

Safety on the Road

Accidents do happen, which is why drivers need to be prepared. Just as you carry the Outdoor Essentials on camping trips, you should carry an emergency kit in your car. Include these items:

- Jumper cables
- Spare fuses
- Two quarts of oil
- A gallon of coolant
- Aerosol tire inflator
- Two roadside flares
- A first-aid kit
- A “help” sign
- An ice scraper
- Windshield deicer
- Spare windshield wiper blades
- A multipurpose tool
- A flashlight
- Rags or paper towels
- A blanket
- Food and water
- A pen and paper



Jumper cables



Ice scraper



Flashlight

Stay Safe While Working on Cars

Exercise caution at all times. A car’s engine, cooling system, and drive train components get very hot, as do their fluids. It is a good idea to always wear gloves and safety glasses. You should also wear old clothing because you will be working with oils, lubricants, and other fluids.

Never go under a vehicle that is not properly braced with a jack stand. When working in the engine compartment, disconnect the negative battery cable. This cuts off power to all the car’s systems, so you will not get a shock or accidentally damage electrical components. It also prevents the electric cooling fan from coming on without warning and hurting you.



Jack stands



Advanced driver assistance systems like these help make today's new cars safer than ever.

Advanced Driver Assistance Systems

Many cars on the road today come equipped with advanced driver assistance systems (ADAS) designed to help the driver be more aware of hazards around them and possibly mitigate on behalf of the driver if a hazardous condition is detected. These systems have been shown to reduce accidents and save lives. While ADAS can assist a driver with hazards — such as vehicles in a blind spot or a pedestrian walking out into traffic — all these systems still require an attentive driver behind the wheel.

Consult the owner's manual to confirm what assistance systems your vehicle has and the guidelines for their operation and maintenance. Components such as radar modules, cameras, and ultrasonic sensors might need to be recalibrated if disturbed while performing other maintenance or if body damage occurs.

Each vehicle manufacturer names its ADAS systems. The American Automobile Association (AAA) has suggested a standard naming convention to reduce confusion among consumers.

Some Auto Safety Systems

- Adaptive cruise control
- Automatic high beams
- Blind-spot warning
- Driver monitoring
- Forward automatic emergency braking
- Forward collision warning
- Lane-keeping assistance
- Rear cross-traffic warning
- Semi-automated parking assistance
- Surround-view camera

Keep Up With ADAS Technology

National Highway Traffic Safety Administration:

nhtsa.gov/equipment/driver-assistance-technologies

SAE Levels of Driving Automation:

sae.org/blog/sae-j3016-update



The Engine

The engine is the single most important part of an automobile. It burns fuel to create heat and then converts that heat into mechanical motion, which makes the wheels go around and makes the accessories work.

Types of Engines

For many years, nearly all cars and trucks had either gasoline engines or diesel engines. Both engine types rely on *internal combustion*, which means that the fuel is burned inside the engine.

More recently, gas-electric *hybrid engines* have appeared. These vehicles have engines that are more fuel-efficient than traditional engines. Automakers are now testing hydrogen fuel-cell vehicles. During your lifetime, other kinds of engines may become common.

Gasoline Engines

To understand how a gasoline engine works, think about a bicycle. When you pedal a bicycle, your body burns the calories in the food you have eaten. This creates the energy your muscles need to move your legs up and down. The bicycle's pedal system changes this movement into circular (*rotary*) motion and sends the motion to the rear wheel through a connecting chain and sprocket.

In a gasoline engine, the "legs" are *pistons*. Pistons are shafts that slide up and down within tubes called *cylinders*. A mixture of fuel and air enters the *combustion chamber* (the space inside the cylinder), where a spark ignites it. This causes a rapid burning (a release of chemical energy) that pushes the piston down inside the chamber. A connecting *rod* and *crankshaft* convert this up-and-down motion (mechanical energy) into rotary motion. A series of shafts and gears then sends this motion to the wheels of the vehicle and makes them turn.

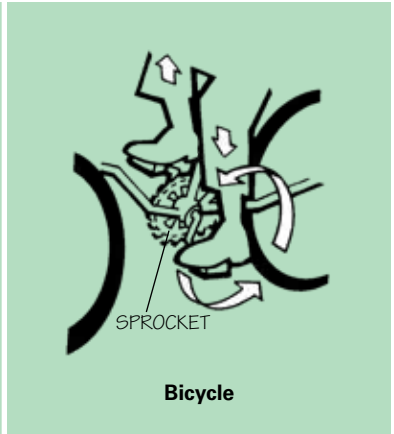
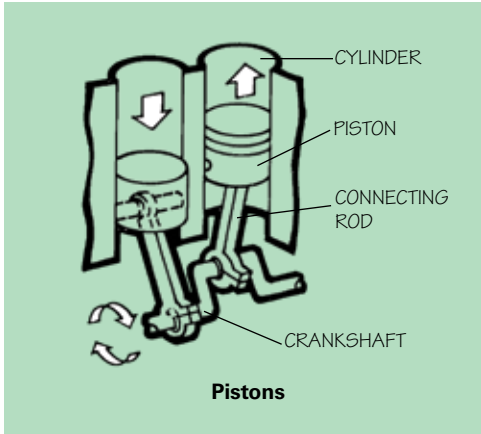

Automobile engine operation is similar to pedaling a bicycle.

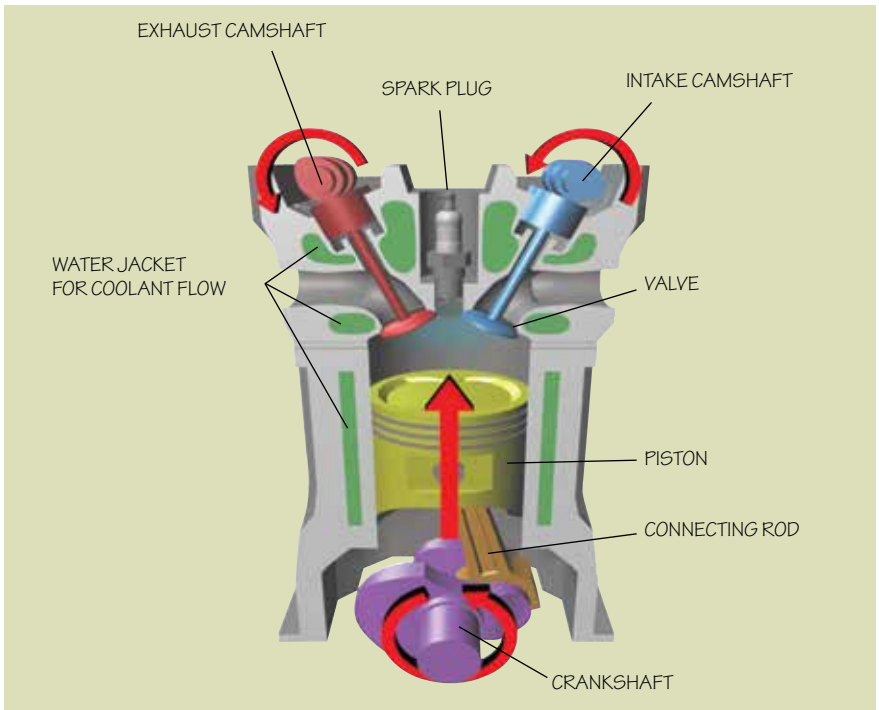

Combustion chamber components

Piston Engines

Most car engines have four, six, or eight cylinders of the same size. In general, the more cylinders an engine has, the more powerful it is.

The cylinders can be arranged in several ways (called *configurations*), including *inline* (or *straight*), *V*, and *opposed* (or *boxer*).



The inline-4 is the most common engine configuration.

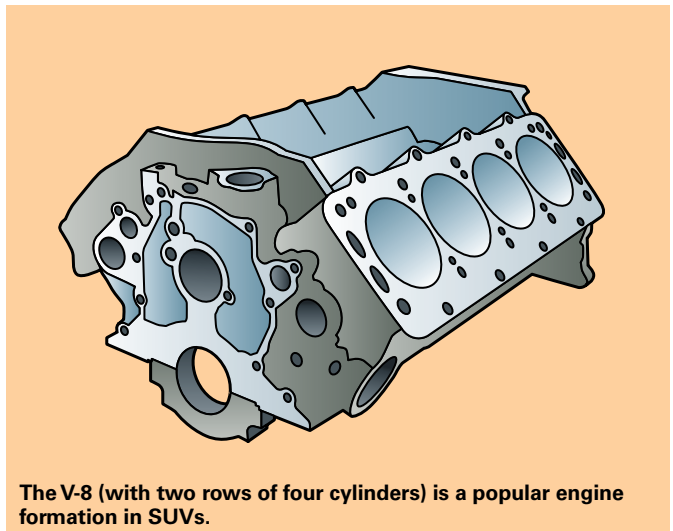

The V-8 (with two rows of four cylinders) is a popular engine formation in SUVs.

Four-Stroke Cycle

It takes four steps, or strokes, for a piston to create energy.

- 1. Intake Stroke.** The intake valve opens, and the piston moves down in the cylinder. This pulls in an air-fuel mixture. Then the intake valve closes.
- 2. Compression Stroke.** When both valves are closed, the spinning crankshaft pushes the connecting rod, which forces the piston up. The piston squeezes the air-fuel mixture in the combustion chamber. This heats up the air-fuel mixture and raises its pressure, making it burn more easily and quickly and produce more energy.
- 3. Power Stroke.** As the piston reaches the top of its stroke, a spark plug ignites the compressed mixture. In about two thousandths of a second, the mixture burns. The gases expand, pushing the piston downward. As the piston moves downward, the connecting rod moves downward, too, and turns the crankshaft, which powers the engine.
- 4. Exhaust Stroke.** The exhaust valve opens as the connecting rod pushes the piston upward. The piston forces the burned gases out of the combustion chamber through the exhaust valve. At the top of the stroke, the exhaust valve closes. The cylinder is now ready for the next intake stroke.

Everything just described happens very quickly. Depending on the car's speed and acceleration (how quickly it gains speed), the crankshaft may rotate between about 700 and 7,000 revolutions per minute (RPM)!

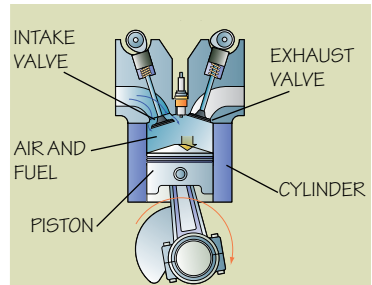

Intake stroke

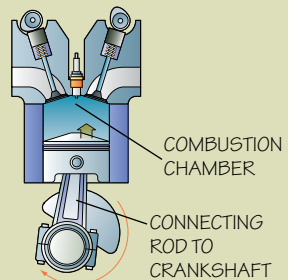

Compression stroke

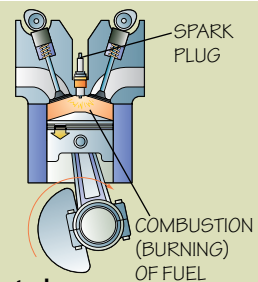

Power stroke

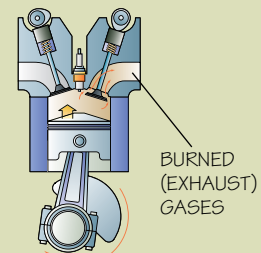

Exhaust stroke

The Valve Train

As you might imagine, a simple four-stroke cycle would produce a jerky motion, because only one stroke would produce power. That is why, in a modern engine, different cylinders are always on different strokes. At any point, one cylinder will be on the intake stroke, one will be on the compression stroke, etc. A heavy spinning weight called a *flywheel* at the rear of the engine provides energy (*momentum*) to help keep the crankshaft turning.

The parts of the valve train work together to open and close the valves at just the right moment. The key part is the *camshaft*, which connects to the crankshaft with gears or a chain. As the camshaft rotates, egg-shaped parts called *cams* open the valves in the right order. (Springs on the valves close them.)

Modern engines have *overhead cams*. This means the camshaft is above the valves, not below them near the crankshaft. Some more powerful engines have dual overhead cams (*DOHCs*). In these engines, there are two intake and two exhaust valves per cylinder.

In internal combustion engines, variable valve timing (*VVT*) can be used to alter the timing of a valve lift event and improve performance, fuel economy, or emissions. *VVT* may be achieved with mechanical devices or electrohydraulic and camless systems.

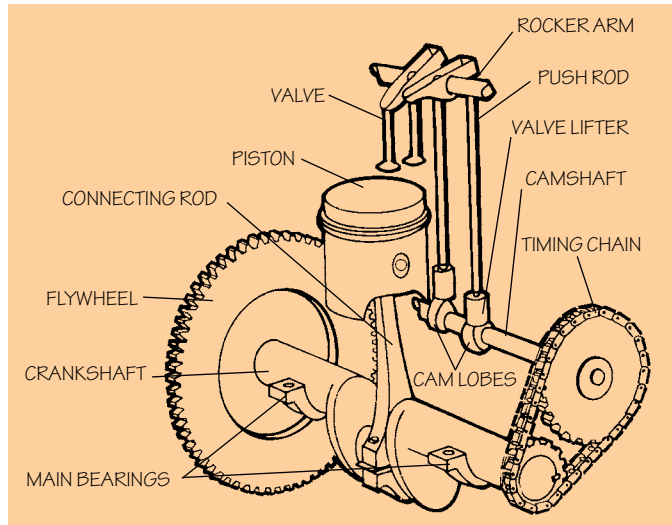

Engine valve train and flywheel

Understanding Diesel Engines

In many ways, diesel engines are like gasoline engines. They belong to the internal combustion family and share many features.

They use a different fuel, however, and the air-fuel mixture is not ignited by a spark plug. Instead, the engine uses compression ignition. This means that the intake stroke draws air into the cylinder by itself. The piston compresses it to a much higher pressure than in a gasoline engine (20:1 for diesel compared to 9.5:1 for gasoline). An injector then sprays fuel into the chamber, and when it becomes hot enough, the fuel ignites.

Gasoline-Electric Hybrid Vehicles

Strictly speaking, a *hybrid* vehicle is any vehicle that uses more than one source of power. Mopeds are one example. They combine the power of a gasoline engine with the rider's pedaling power. Locomotives are another example. They are typically diesel-electric hybrids.

In the late 1990s, automakers began introducing gas-electric hybrid cars. A gas-electric hybrid car has a gasoline engine that is like (but smaller than) a typical car engine. It also has an electric motor that helps power the car and its accessories, such as power steering and air-conditioning. When the driver applies the brake, the energy that is created recharges the battery.

Many car manufacturers are in the early stages of producing extended range electric vehicles (EREVs) and plug-in hybrid electric vehicles (PHEVs).

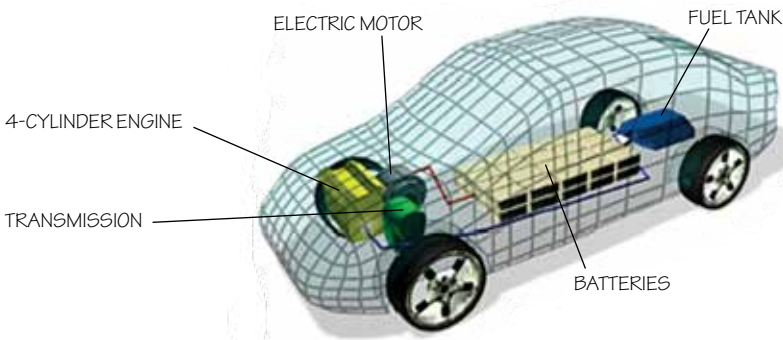

Gasoline-electric parallel hybrid drive train

How Electric Vehicles Work

An electric vehicle (EV) works differently than a traditional gasoline car. Instead of using an internal combustion engine that runs on gasoline, an EV uses an electric motor powered by electricity stored in a large battery.

Here's how:

- 1. Battery:** EVs have a big battery pack, usually located under the floor or in the back of the car. This battery stores electricity, much like how your phone stores power. The battery is charged by plugging it into a charging station or a wall outlet.
- 2. Electric Motor:** The electric motor in an EV is like the engine in a regular car, but it runs on electricity. When you step on the accelerator pedal, the electric motor receives electricity from the battery and uses it to generate motion. This motion makes the car move.
- 3. Controller:** The controller manages the flow of electricity from the battery to the electric motor. It helps control the speed and power of the motor, which is what allows you to speed up, slow down, and steer.
- 4. Regenerative Braking:** When you take your foot off the accelerator pedal or hit the brakes, some EVs use a cool feature called regenerative braking. This means the electric motor acts like a generator, converting the car's kinetic energy back into electricity to recharge the battery a bit. It's like a little energy boost when you slow down.
- 5. Charging:** To keep your EV running, you need to charge it by plugging the car into a charging station or a wall outlet.

There are different types of chargers with varying speeds—some can give you a quick charge, while others take more time but give you a lot of energy.

- 6. No Tailpipe Emissions:** Unlike regular cars that burn gasoline and produce exhaust, EVs produce zero tailpipe emissions. This means they're better for the environment and help reduce air pollution.



This process makes electric vehicles efficient and eco-friendly. They are becoming more popular as technology improves.



Today, most electric-vehicle charging occurs at the car owner's home. Public charging stations, which work much like a typical gas station, are becoming more common.





The Drive Train

The drive train is the set of parts, starting with the transmission, that send power from the engine to the wheels. Most cars today use front-wheel drive (FWD), so the drive train connects just to the front wheels. Other vehicles use rear-wheel drive (RWD). Many trucks and SUVs feature all-wheel drive (AWD) or four-wheel drive (4WD), which means the transmission powers all four wheels.

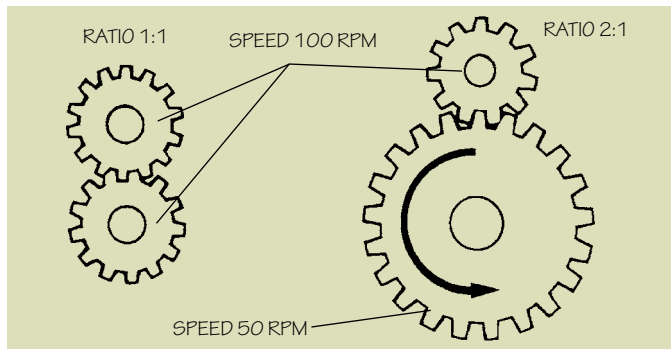

The ratio between the size of two gears affects the torque the gears generate.

The Transmission

Every engine produces the most horsepower and *torque* (twisting power) at or near a certain speed—say, 5,000 rpm. However, the wheels do not always need the same amount of power, so the transmission multiplies torque by sending power between different-sized gears.

When a smaller gear turns a larger gear, the bigger gear rotates more slowly and sends more power to the wheels. For example, if a 3-inch gear turns a 6-inch gear (a 2:1 *gear ratio*), the smaller gear turns twice as fast, but the larger gear creates twice the torque.

You may have seen this idea at work on a bicycle. If your chain is on a small chain ring in the front and a large sprocket in the back, it will help you climb a very steep hill. If it is on a large chain ring and a small sprocket, it will help you pedal along a flat road at high speed.

A key difference between a car transmission and a bicycle gear set is that on a bicycle, you can use any chain ring with any sprocket. On a car, however, the gears on the *input shaft* (coming from the engine) and the output shaft (going toward the wheels) are always connected in pairs. Each time you shift gears, the transmission tells a different pair of gears to send power to the wheels.

There are two basic types of transmissions: manual and automatic.

Manual Transmissions

With a *manual transmission*, just before shifting gears, the driver must push a pedal down to release the *clutch*. This temporarily disconnects the wheels from the engine so the driver can select a gear by using a *shift lever*.

The clutch has a round disc, about the size of a dinner plate, that is covered with friction material. When the clutch pedal is out, this disc rests tightly against the engine *flywheel*. This makes the transmission's input shaft spin at the same speed as the crankshaft.

Manual transmissions are sometimes called standard transmissions.

Automatic Transmissions

An automatic transmission shifts itself. There is no clutch pedal; the driver just has to move the shift lever to D (drive) to use the car's forward gears. *Hydraulic* (fluid) pressure flowing through various pathways does all the work. An automatic transmission senses engine speed and vehicle speed, and then picks the appropriate gear ratio.

The axle differential is a gear system that allows a car's wheels to spin at different speeds during turns. When the car turns, each wheel travels a slightly different distance; the differential helps to even out that difference so the driver can maintain control.

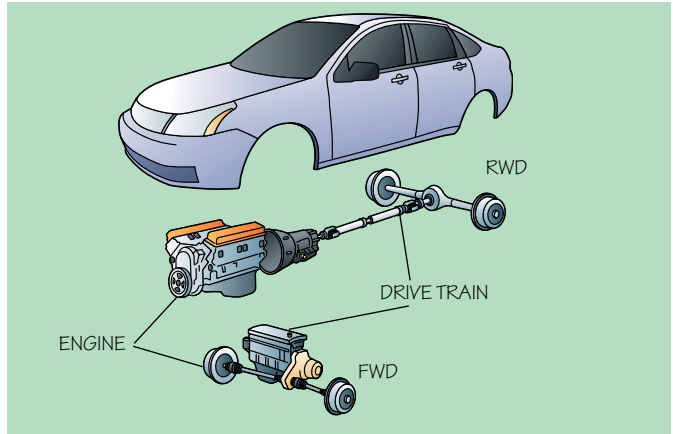

Other Drive Train Components

The makeup of the drive train varies depending on whether a vehicle is FWD, RWD, or 4WD/AWD.

In FWD vehicles, the engine is mounted *transversal*; the driveshaft goes from side to side, not front to back. A combination transmission and axle—called a *transaxle*—sends power directly to axle shafts, which turn the front wheels.

In RWD vehicles, the engine, transmission, driveshaft, and *axle differential* connect in a straight line like cars on a train. Power from the engine makes a right turn at the rear axle differential, then the axle shafts send power to the rear wheels.

The drive trains on 4WD and AWD vehicles are set up like those on RWD vehicles. The *transfer case* on the transmission distributes power to the front wheels through a second drive-shaft and front axle assembly.

The Differential

The differential is inside the rear axle housing (on RWD vehicles) or the transaxle (on FWD vehicles). It has a special set of gears, called a *ring and pinion*. The driveshaft turns the smaller pinion gear, which sends power at a 90-degree angle to the ring gear. As in the transmission, twisting power increases as the smaller pinion turns the larger ring gear. Most axle gear ratios are around 2.75:1, which gives good overall performance. A lower ratio, such as 3.98:1, offers more fuel economy but slower acceleration. A higher ratio, such as 2.10:1, creates more power and acceleration.

Checking Transmission Fluids

Manual transmissions and rear axles use *gear lubricant*, which is a little heavier than motor oil. This fluid does not need to be changed unless there is a problem. You can check the level by unscrewing the metal filler plug while the vehicle is on a hoist.

Put your fingertip or a piece of wire into the opening. The lubricant should be even with the opening's lower edge.

Automatic transmissions use a lightweight fluid that not only lubricates but also works the hydraulic circuits. Different manufacturers call for slightly different types of fluid.

You can check the transmission fluid level with a dipstick, which is usually at the rear of the engine compartment. Make sure the shift lever is in park and set the parking brake. With the engine idling, pull out the dipstick, wipe it off with a clean, lint-free cloth, put it in again, and pull it out again. If the fluid level is at or below the "Add" mark, top it off.

The transaxle on FWD cars with manual transmissions uses a single fluid (similar to RWD cars). Cars with automatic transmissions use one fluid for the differential and another fluid for the transmission part of the transaxle.

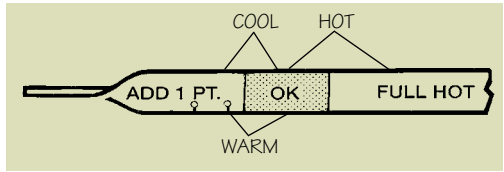

Checking the transmission fluid

Transmission fluid readings are most accurate after someone has driven the vehicle for 20 or so miles to warm up the fluid.

Checking the Power Steering Fluid

The power steering system uses hydraulic pressure to make it easy to turn the steering wheel. Power steering fluid should be checked often and replaced according to the specifications in the owner's manual. To check the fluid level, take the cap off the top of the power steering pump, which usually can be found at the front of the engine on the driver's side. If fluid is needed, add it to the reservoir. Some cars have a clear plastic reservoir that lets you check the level without taking the cap off. Rock the car gently to see the fluid level.



Wheels and Tires

Wheels and tires go together like peanut butter and jelly. While we could make car wheels that did not need tires, the ride would be very rough. (Imagine being pulled along in a child’s wagon at 65 miles per hour!) Tires help soften the ride and grip the road, even when the road is covered with rain, snow, or mud.

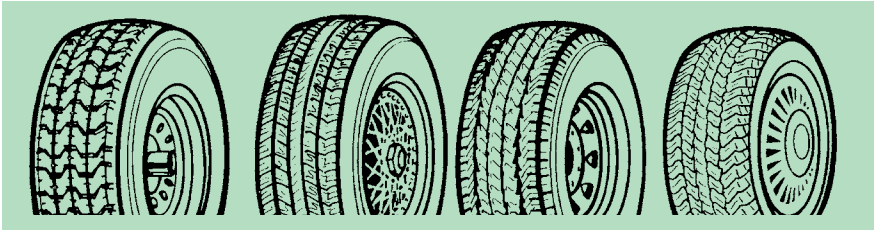

Examples of various tire treads and wheels

Wheel Design

Most wheels are made of stamped steel. Others are made of cast aluminum, which is stronger and can be made in different designs for a special look. Four or five lug nuts connect the wheel to the axle shaft.

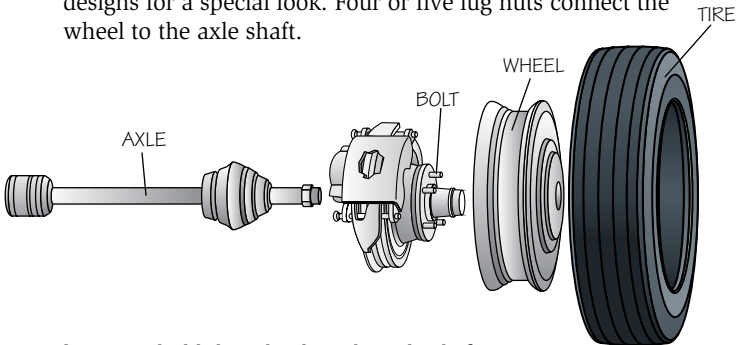

Lug nuts hold the wheel on the axle shaft.

Tire Design

Every tire has three main parts: the tread, the sidewalls, and the beads. The *tread* is the part that touches the road. Its grooves are paths for water to run off, which improves *traction* (grip). The *sidewalls* are between the tread and the wheel rim. These smooth, flexible sections absorb shocks and cushion the ride. They also create a space that holds air. The sidewalls end at the *beads*, sturdy steel rings that hold the tire within the rim.

Directional tires have a one-way tread pattern that is optimized for the direction the tires rotate on the car. These tires are specifically made for either the left or right side. The grooves are angled to make handling easier and to channel water out from under the tire on wet surfaces, which improves traction and reduces the risk of hydroplaning. Small arrows or triangles on the sidewall show which way the tire is supposed to turn.

The tread pattern on nondirectional tires is designed in a way that allows the tires to turn in any direction.

Inside the Tire

The interior of the tire is strengthened with several layers, or *plies*, of rubber-coated fabric cord. In most car tires, called *radial-ply* tires, these cords run at (or near) a right angle to the center of the tire. These tires stay cooler, have a softer ride, and have a longer tread life.

Most radial tires have steel belts, which is why they are often called *steel-belted radials*. The belts help the tires resist punctures and help flatten the tread, which improves traction.

Tire Wear Indicators

Many tires have wear indicators in the tread. When only about $\frac{1}{16}$ of an inch of tread is left, you can see a band running from one side of the tire to the other. This means the tire is near the end of its useful life.

Never mix directional and nondirectional tires on the same vehicle.

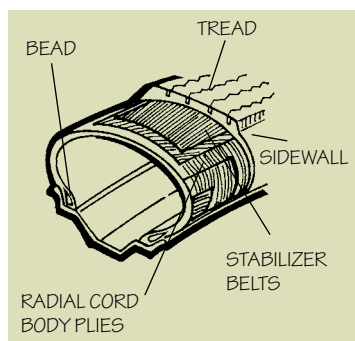

Most passenger car tires use the radial-ply design.

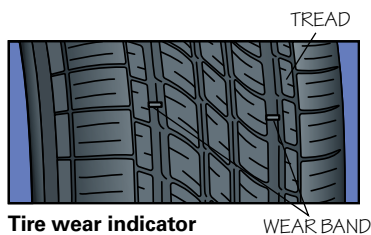

Here is a quick way to see if a tire has sufficient tread: Stick a penny top first into one of the grooves. If you can see the top of Abraham Lincoln's head, the tire should probably be replaced.



Tire Specifications

A sign on the driver-side door or doorjamb (or inside the glove box or engine compartment) tells you the proper tire size, inflation pressure, and sequence for rotating tires. Tires can also tell you a lot of information about themselves.

Tire Size and Inflation

A typical passenger tire size is P215/65R15. These letters and numbers are a code. Here is what that code tells you:

- **P** stands for *passenger*.
- **215** means the tire's width is 215 millimeters.
- **65** means the tire's height is 65 percent of its width (the *aspect ratio*).
- **R** stands for *radial-ply*.
- **15** means the wheel's diameter is 15 inches.

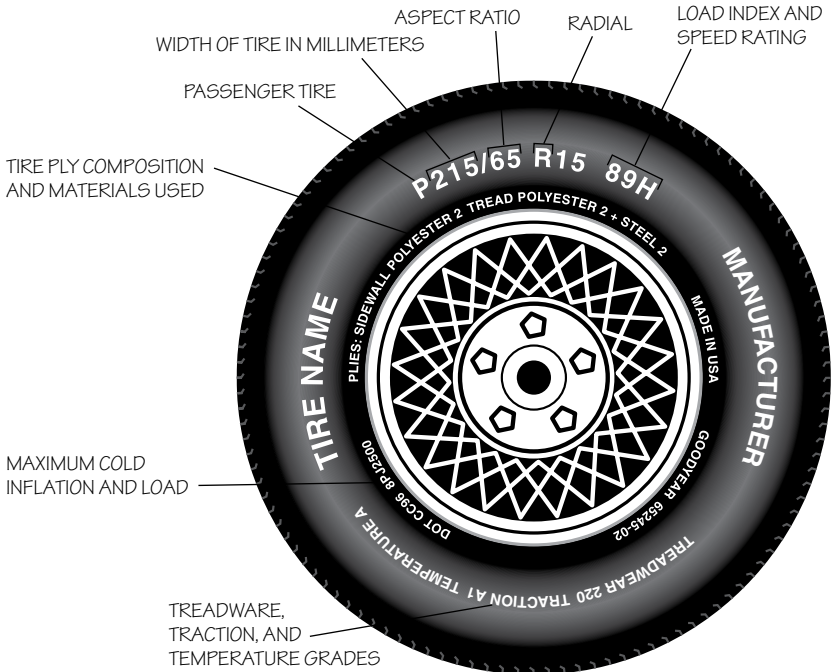

Tire specifications are on the sidewall.

You will find a tire's size on its sidewall, along with some other information:

- The maximum allowable inflation pressure in pounds per square inch
- The tire's load index and speed rating
- The tire's maximum load rating
- Information about the tire's construction
- The tire's grades for tread wear, traction, and temperature

The most important of these numbers—and the easiest to understand—is the inflation pressure. Tires work best and last longest when they are properly inflated. In addition, fuel efficiency goes down by 1 percent for every 3 pounds per square inch that tires are underinflated.

If the inflation pressure listed on the tire is different from the pressure noted on the vehicle, use the pressure noted on the vehicle. It is what the manufacturer recommends.

You should check the pressure of all tires, including the spare tire, once a month. Add air as needed with an air hose. You can use a handheld tire gauge. (The round ones are more accurate than the pen-shaped ones.) You can also use the gauge that is part of the air hose.

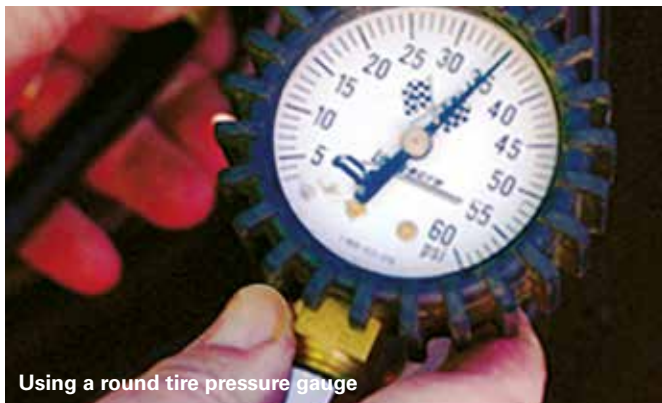

Using a round tire pressure gauge

For an explanation of other information found on tires, get your parent or guardian's permission and visit the SaferCar.gov website.

Tire Rotation

Tires tend to wear unevenly, both front to rear and side to side. To make them last longer, manufacturers recommend that you regularly move them from wheel to wheel. This is called *rotating* the tires. Typically, you should rotate new tires after the first 7,500 miles and then every 15,000 miles.

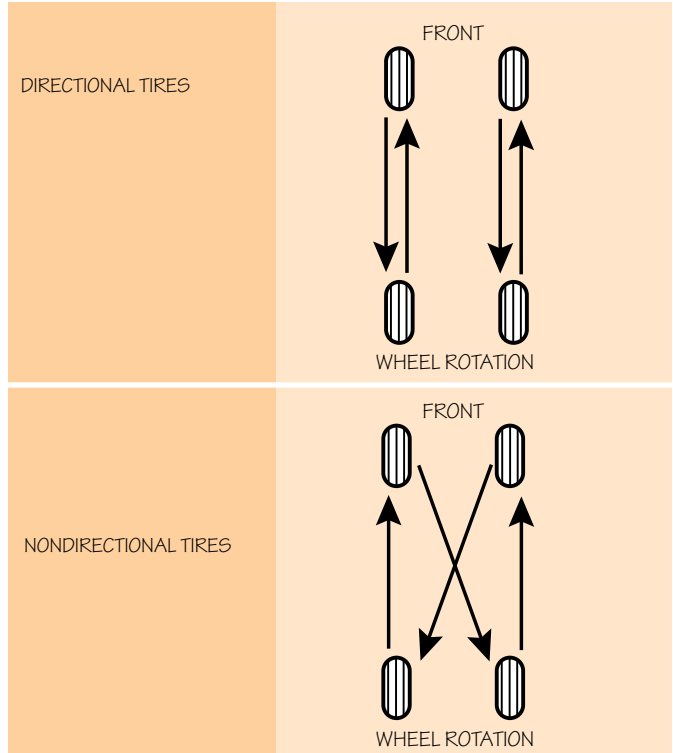

Directional and nondirectional tires have different rotation patterns.

Wheel Alignment and Tire Wear

Wheels may look like they are set straight up and down, but they are actually set at slight angles to help improve vehicle handling and tire life. It is important to keep wheels aligned; misaligned wheels will shorten the life of your tires.

Camber

Camber is the inward or outward tilt of the wheel, as seen from the front of the vehicle. It is measured in degrees between vertical and the tire's centerline. Inward tilt is *negative camber*. Outward tilt is *positive camber*.

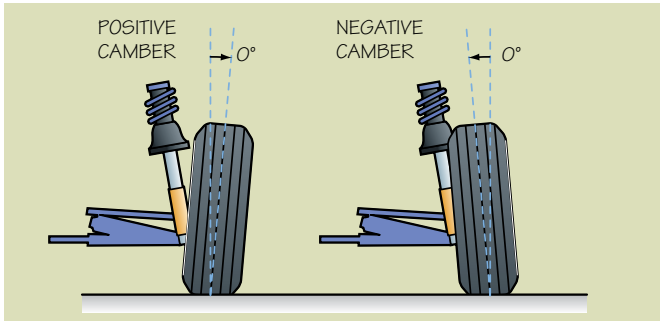

A front wheel, viewed from the front of the car

Caster

Caster is the angle that the steering axis is offset from the vertical, as viewed from the side. It increases directional stability, such as when the car is on an unstable surface (rough or slick, for instance). (That is why the fork on a bicycle connects at an angle to the hub of the front wheel.) Caster is measured in degrees. Backward tilt is *positive caster*. Forward tilt is *negative caster*.

A front wheel, viewed from the side of the car

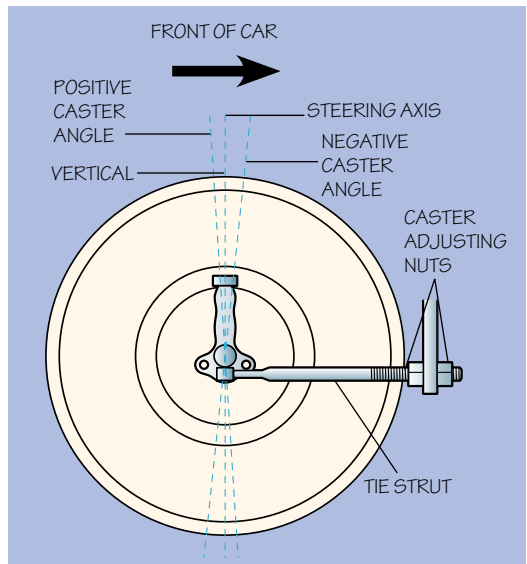

How to Change a Tire

Road hazards like nails and broken glass can puncture a tire's tread. When that happens, you need to be able to change the tire. In most cars, you will find the spare tire under the floor of the trunk. A jack and lug wrench should also be there. Before you begin, put the transmission in park (or in gear if it is a manual transmission), and apply the parking brake. Have the spare tire, jack, and lug wrench handy. Then follow these key steps in changing a tire.

Step 1—Stabilize (chock) the wheel that is diagonally opposite the flat tire by putting bricks, logs, or other heavy objects in front of and behind it.

Step 2—Pry off the wheel cover or hub ornament with the narrowed end of the lug wrench.

Step 3—Loosen, but do not take off, the lug nuts with the wrench. You may have to step on the end of the lug wrench to make it turn.

Step 4—Find the notch under the door panel nearest the flat tire, and center the jack there. Turn the handle of the jack clockwise until the wheel is all the way off the ground.

Step 5—Remove the lug nuts and put them in a safe place, such as inside the wheel cover. Then, pull the wheel off the vehicle.

Step 6—Put on the new wheel and tire.

Step 7—Put the lug nuts back on with the tapered edges facing inward; hand-tighten them.





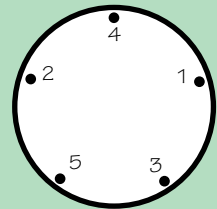





Step 8—Lower the vehicle by turning the jack handle counterclockwise. Remove the jack.

Step 9—Tighten the lug nuts all the way, following the order in the picture. Put the wheel cover or hub ornament back on. Put the jack and lug wrench back in the trunk, along with the flat tire. Get the flat tire fixed as soon as possible.

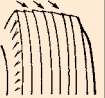

Tighten the lug nuts in this order.

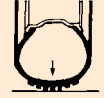
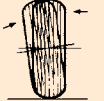
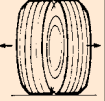
Tire Wear Patterns

Condition	Rapid Wear at Shoulders	Rapid Wear at Center	Cracked Treads	Wear on One Side	Feathered Edge	Bald Spots	Scalloped Wear
Effect							
Cause	Under-inflation or lack of rotation	Overinflation or lack of rotation	Under-inflation or excessive speed	Excessive camber	Incorrect toe	Unbalanced wheel	Lack of rotation of tires or worn or out-of-alignment suspension
						 Or tire defect	
Correction	Adjust pressure to specifications when tires are cool; rotate tires.			Adjust camber to specifications.	Adjust toe-in to specifications.	Dynamic or static balance wheels.	Rotate tires and inspect suspension.

Incorrect wheel alignment causes abnormal tire wear.

Toe-In/Toe-Out

The *toe* of a tire is measured in fractions of an inch. It affects how evenly the tire will wear. A wheel's toe measurement is the difference in the distance between the front edges and the back edges of a pair of tires. *Toe-in* means the front edges of the tires are closer together. *Toe-out* means they are farther apart.

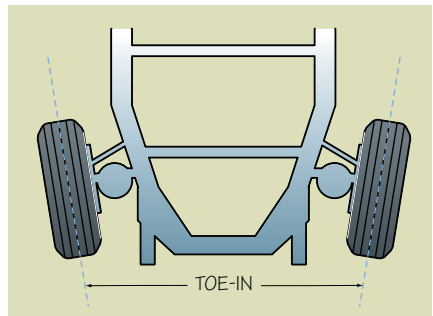

Front wheel toe alignment viewed from top of car

Disposing of Old Tires

Tires eventually wear out. They must be disposed of properly. Ask a local tire dealer about local rules for getting rid of old tires. Millions of tires are recycled every year. They become things like playground mulch, patio decking, and even artificial reefs.



The Braking System

The braking system allows the driver to control the speed of the vehicle by applying *frictional force* (resistance) to the rotating wheels. This slows or stops the vehicle.

How the Braking System Works

Two things happen when the driver's foot pushes the brake pedal down. First, a *hydraulic* (fluid-filled) circuit multiplies this pedal pressure and sends it to all four wheels. Second, the hydraulic pressure at each wheel pushes against brake pads or linings, which have a special cloth called *frictional material* attached. These pads or linings rub against a rotating cylinder called a *drum* or *rotor* that is attached to the wheel. Friction makes the wheel slow down.

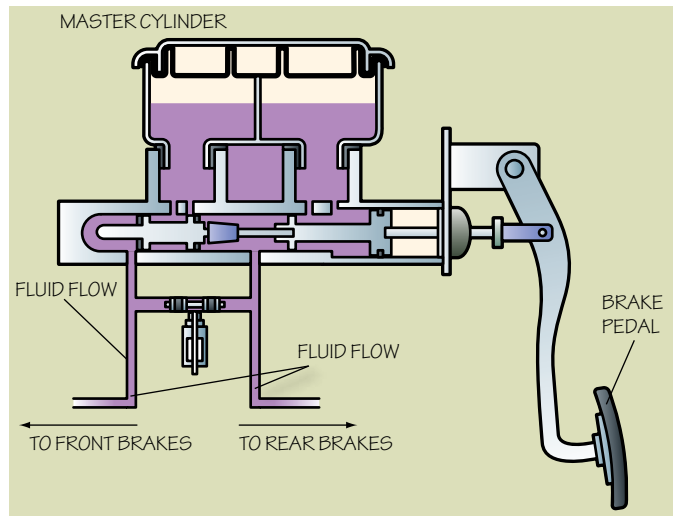

When the driver presses the brake pedal, the master cylinder piston moves forward, creating braking force at the wheels.

What Is Friction?

Friction is resistance to motion. If you run on a gym floor in hard-soled shoes, you will slide when you try to stop or change direction quickly. If you are wearing sneakers, it is much easier to stop and turn. That is because rubber has higher friction than other materials. Automotive brakes need to be made of much tougher materials than shoes. They are made of special compounds that lose heat quickly and wear very slowly.

Hydraulic Circuit

The brake pedal is attached to a *master cylinder*, which holds two containers (*reservoirs*) of brake fluid and two plungers. When you apply the brake pedal, the plungers force fluid through steel tubing to the wheels. The fluid presses against wheel cylinders, which in turn move the brake pads or linings to create friction. This changes motion energy into heat energy that goes out easily into the air.

The brake system needs hydraulic pressure to build up when the driver presses the brake pedal. If there is a leak in the system, pressure cannot build up and the brakes will not work. To prevent dangerous brake failure, modern cars have two separate brake circuits. (That is why the master cylinder has two fluid reservoirs and two plungers.) If one circuit has a leak, there will still be braking power in the other. Typically, the circuits are *cross-linked*, which means that one circuit powers the left-front and right-rear brakes, while the other powers the right-front and left-rear brakes.

Types of Braking Systems

There are two major types of brakes: drum brakes and disc brakes. *Drum brakes* force curved pads, called *brake shoes*, to rub against the inside of an iron drum. *Disc brakes* use pairs of levers, called *calipers*, that clamp small brake pads against the sides of a spinning iron disc, called a *rotor*. (This is how bicycle brakes work, too.)

Disc brakes are better for severe operating conditions, because air cools the rotor, helping heat go away more quickly. New cars usually have drum brakes in the rear and disc brakes in the front. High-performance models have disc brakes at all four wheels.

Antilock Brakes

To stop or slow a moving vehicle, you need two kinds of friction: friction between the brakes and the wheels and friction between the wheels and the road. If the driver hits the brakes too hard and the wheels *lock up* (stop turning), the car can skid out of control. An *antilock braking system* (ABS) keeps the wheels from locking up by adjusting the amount of pressure they apply to each brake.

When sensors feel that a wheel is about to stop turning, the ABS computer tells the brake system's hydraulic control unit to use less braking force at the wheel or wheels that are about to lock. This balances the braking at all four wheels and gives the driver better control of the vehicle.

In order for ABS brakes to work properly, the driver should apply steady pressure to the brake pedal rather than pumping it. If the driver can hear mechanical noise or notice "pulsing" during a hard brake, the ABS system is working.

Brake Maintenance

Brake fluid levels can go down over time. They can go down quite fast if there is a leak in the system. Brake pads and linings must be replaced periodically. How quickly they wear out depends on drivers' habits, such as how hard and how often they brake and whether they drive in a lot of stop-and-go traffic.



Checking the brake fluid

Checking the Brake Fluid

To check the brake fluid, take the cap off the top of the master cylinder. It is on the driver's side of the engine compartment near the *firewall* (protective barrier that separates the passenger from the engine). If necessary, top off the fluid with fresh brake fluid. Use the kind called for in the owner's manual (probably DOT 3).

Some cars use a clear plastic top that lets you check the fluid level without taking off the cap. Rocking the car gently helps you easily see the fluid level.

Inspecting the Brakes

Most manufacturers recommend that you check the brakes after the first 6,000 miles, then at every scheduled service interval. You should check the brakes as soon as possible if you notice any of these problems:

- The brake indicator or ABS indicator on the dashboard lights up.
- The brake pedal goes almost to the floor before you feel the brakes go on. This could indicate a low brake fluid level or a fluid leak.
- You hear a squealing sound. This could mean that the brake pads are wearing thin.
- You feel vibration or shaking or hear the sound of metal on metal; this could mean that the rotors are damaged.

To check your brakes, safely jack and support the vehicle, then remove the wheel and assembly. Remove the brake drum, if there is one. Check the pads or linings for wear, and replace them if the frictional material is worn to within about $2/32$ inch (1.588 mm) or less of the metal shoe. Inspect the rotors and look inside the drums for damage or overheating. These problems will cause a bluish color. Light scratch marks are acceptable, but if the marks are more than 0.015 inch ($1/64$ inch) deep, you need to replace the rotor or drum or take it to a shop that can machine it to make the surface smooth again.



Disc brake pads



Drum brake shoes



The Air Intake and Fuel Systems

As mentioned earlier, automobile engines burn a mixture of fuel and air. The air intake and fuel systems work together to create this mixture.

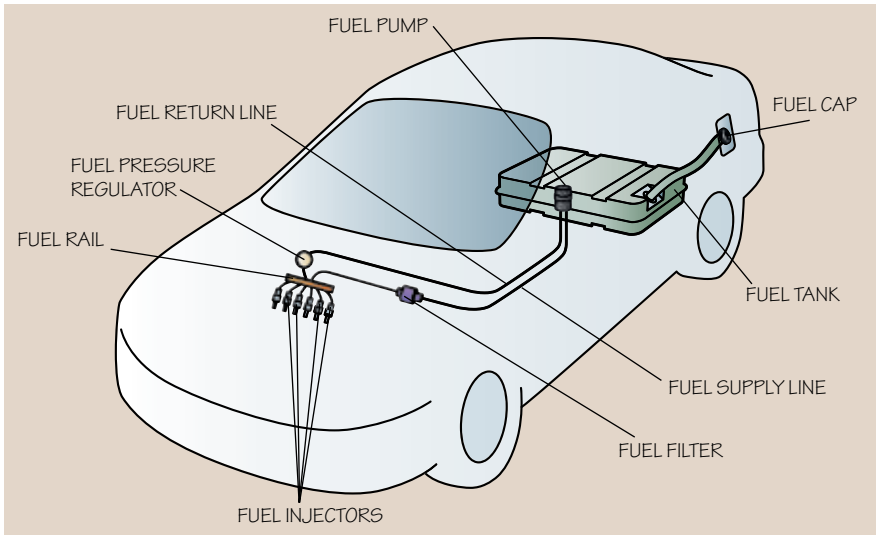

Typical fuel injection system

Operating Principles

The air intake and fuel systems use many different devices and subsystems, including a computer called the *engine control unit*, to make sure the engine uses the right mixture of air and fuel. These systems may seem complex, but they rely on three basic principles: air-fuel mixture, pressure, and gasoline vaporization.

Air-Fuel Mixture

The combustion process creates power by burning a mixture of air and gasoline. The amounts of each, however, change all the time because of differences in temperature, vehicle speed, and terrain. The engine burns fuel best, with the most complete combustion and the lowest emissions, when it mixes 14.7 parts of air with one part of gasoline. This is written as 14.7:1 and is called the *air-fuel ratio*. (Because the engine needs such a precise ratio, the air-fuel ratio is computer-controlled.)

The car may need a *rich* mixture, with less air and relatively more fuel (like a ratio of 8.0:1), when starting on a cold morning or when speeding up to pass another vehicle. A *lean* mixture, with more air and relatively less fuel (like a ratio of 17.0:1), may be all the car needs to cruise at low speed with a warm engine.

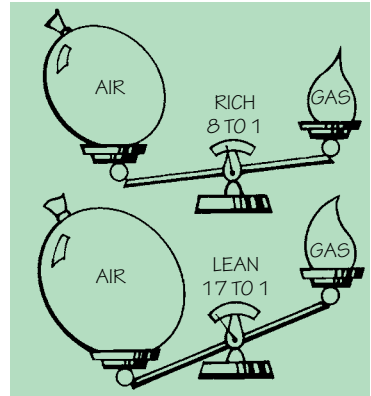

Different air-fuel ratios are required for different operating conditions.

Vacuum and Pressure Relationships

Air inside a balloon is under much higher pressure than air outside. That is why the air will rush out of a balloon if you do not tie the end. The same principle is at work inside a car engine.

As the piston moves downward, it leaves a vacant space of low pressure called a *vacuum*. Air rushes in to fill the space. As this airstream flows into the engine, the engine takes in gasoline to create the combustible air-fuel mixture.

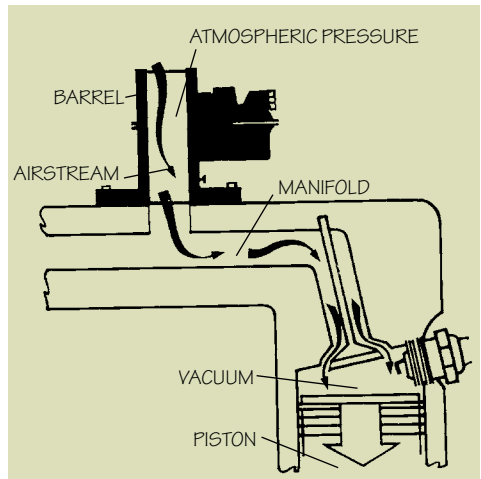

Higher atmospheric pressure makes air flow into the engine. The intake stroke creates a vacuum (low pressure).



The fuel system first breaks gasoline into droplets, much like a spray bottle for household cleaner works. The engine's heat then vaporizes the droplets as they go into the combustion chamber.

Preparing Gasoline for Combustion

Liquid gasoline will not burn. When you see flames above a pool of gasoline, you are really seeing gasoline vapors on fire. Turning liquid gasoline into flammable vapors (called *atomization*) is one of the main functions of the fuel system. It does this by spraying droplets of fuel into the airstream. This is similar to the way a spray bottle works. These tiny droplets of gasoline heat up and vaporize just before they go into the combustion chamber.

A backfire occurs when the air-fuel mixture explodes outside the combustion chamber.

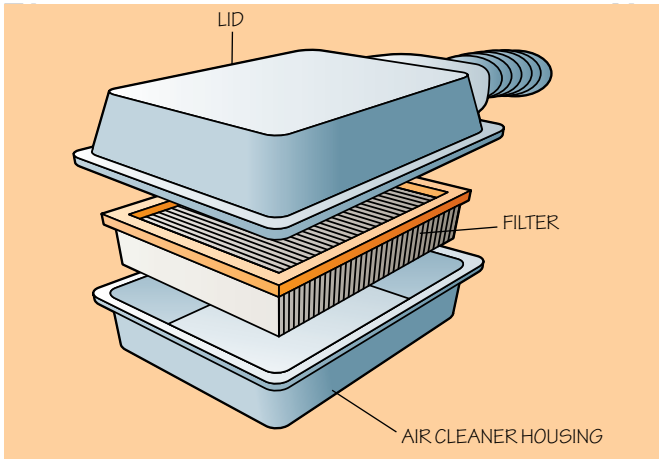

Flat air cleaner assembly

Intake System

Engines use lots of air. Remember the 14.7:1 air-fuel ratio? It describes the amounts by weight. Because air is lighter than gasoline, the average engine uses about 9,000 gallons of air for each gallon of gasoline!

Air enters the engine through the air intake system at an *inlet tube*, passes through an *air filter*, enters an *intake manifold*, and then passes through an *intake valve* into a *combustion chamber*.

Besides pulling air into the engine, the air intake system also filters dust and dirt particles from the airstream. These things can cause serious damage inside the engine due to abrasion or plugged passageways.

Most engines use a paper filter to clean the incoming air. The paper is treated with a *resin* (a sticky substance made from petroleum) and has folds like an accordion. The filter has a metal screen outside and a fine wire mesh inside to resist engine *backfires*. The filter is inside an air cleaner assembly, typically located in a rectangular box at the side of the engine.



Air filters are either flat, as shown in the illustration above, or round like this one.



Checking the air filter

The Department of Energy reports that changing a clogged air filter can improve fuel efficiency by as much as 10 percent.

Air Filter Maintenance

The air filter traps *debris* (waste) in the paper. Eventually the small pores of the paper plug up. You should check the filter from time to time and replace it if there is too much debris. Refer to the owner's manual for the recommended replacement interval (typically 30,000 miles) and step-by-step instructions.

The Fuel System

Metering is the process of measuring gasoline and delivering it to the engine. A car can use one of two methods to meter gasoline: *carburetion* and *fuel injection*. Carburetion relies on the vacuum that incoming air creates to add fuel to the engine. Fuel injection uses computer-controlled jets to atomize fuel and pump it into the cylinders.

Fuel injection is more efficient than carburetion and creates less pollution. All cars sold in the United States since about 1990 have used fuel injection.

Fuel Injection

Fuel injectors are computer-controlled valves that shoot precise amounts of atomized fuel into the engine. When you press the accelerator, a throttle valve opens and lets air into the engine. (The gas pedal should really be called the air pedal!) The engine control unit senses this action and turns on the fuel injectors.

How much fuel does the engine need? This depends on many factors, including engine speed, engine load, barometric pressure, airflow, coolant temperature, throttle valve angle, and exhaust oxygen content. Based on these factors, the engine control unit decides how long to keep each injector open (the *pulse width*) and exactly when to inject the fuel so it will happen when the piston is on the intake stroke.

The injectors may be located in the throttle body itself or in the intake manifold near each cylinder:

- In *throttle-body fuel injection*, one or two injectors add fuel to the air before it reaches the cylinders.
- In *multiport fuel injection*, there is an injector near each cylinder. Half the injectors fire at a time.
- In *sequential fuel injection*, an injector near each cylinder fires just before the cylinder opens. Most cars sold in the United States use sequential fuel injection.

The Fuel Tank and Fuel Delivery System

The fuel tank is at the rear of the vehicle. Fuel leaves it through a device called a *fuel pickup*, which is covered with a finely woven fabric or metal screen that traps large particles of dirt, rust, scale, and moisture. It seldom requires replacement.

Locate your fuel filler cap, which is probably on one of the car's rear quarter panels. Some older cars, however, hide filler caps behind the license plate or even behind a taillight!

A fuel pump forces fuel through metal tubing to the fuel injection system. The pump is usually inside the fuel tank.

A second fuel filter is either on the top of the fuel pump module/pressure regulator assembly or in the fuel line. If this filter is outside the fuel tank, it may be either under the car or in the engine compartment. The filter element may be made of pleated paper or another material.

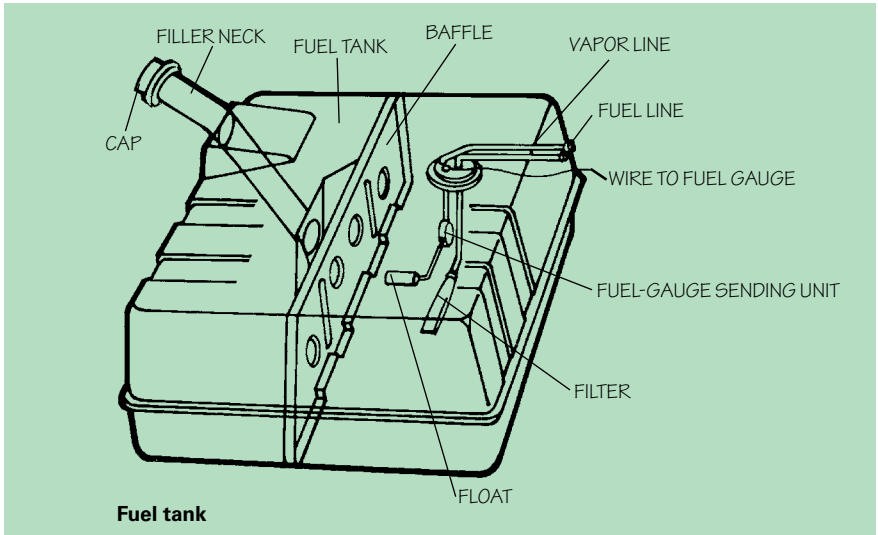

Fuel Filter Maintenance

The inline filter traps very small pieces of debris so they do not plug fuel system passages. Some of these pieces are smaller than the diameter of a human hair. Most newer vehicles do not specify how often to check fuel filters. Use common sense. If the engine seems to be starving for fuel, check the filter. Replace the filter if it is dirty.



Typical fuel filter



Fuel Additives

After crude oil is refined into gasoline, producers add compounds (different kinds of chemicals) to make it a better fuel. These include inhibitors, which keep the system clean by controlling sticky deposits and slowing corrosion (rust), and detergents, which keep deposits from building up. (This is important in fuel-injected engines, which have very small openings.) In winter, manufacturers may add alcohol, which keeps gas lines from freezing. Because of local emission laws, some states require manufacturers to sell winter and summer blends of fuels according to the season.

For many years, manufacturers added lead to prevent a pinging sound made during acceleration and to lubricate valves. However, lead is a health hazard and also can hurt a car's catalytic converter (a device that reduces exhaust emissions). Today U.S. gas stations sell only unleaded gasoline. Gasoline manufacturers use other additives to prevent pinging.

The Lubrication System

When pistons and other engine parts move, they make friction and heat. Oil reduces the friction and carries away the heat. It also reduces corrosion and works as a seal to keep combustion gases from passing between the piston and cylinder walls.

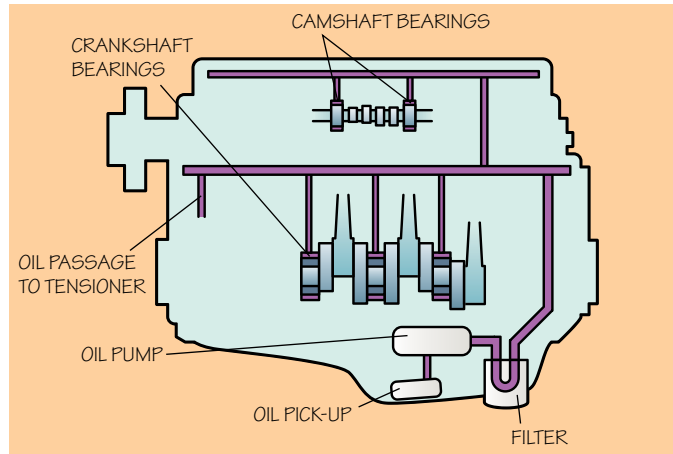

Lubrication system components

How Oil Circulates Through the Engine

Engine oil goes in a pan at the bottom of the engine. This pan is called the *crankcase* because the crankshaft rotates in it and splashes oil on various surfaces. An oil pump forces the oil through all parts of the engine. Gravity makes the oil return to the crankcase.

As the oil flows through the engine, it passes through an *oil filter*, which takes out rough particles the oil has picked up. Most filters are made of paper that is soaked in resin and folded like an accordion.

Types of Oil

Different engines and different operating conditions need different types of oil. The Society of Automotive Engineers and the American Petroleum Institute have codes that define various oil types.

The API has a two-letter code that starts with *S* for gasoline engines and *C* for diesel engines. The second letter tells you the general quality level. Letters nearer the end of the alphabet mean higher quality. For example, *SM* (the standard as of 2004) is better than *SL*.

Diesel service codes have a number at the end to indicate a four-stroke or two-stroke engine: *CJ-4* (the standard as of 2006) is for four-stroke engines. If an oil works in both gasoline and diesel engines, it will have a code like *SM/CJ-4*.

The SAE number tells you the oil's *viscosity* rating, which measures how easily the oil flows. When oil is cold, it gets heavy and thick like pancake syrup. When it is hot, oil is light-colored and runny like water. Manufacturers measure an oil's viscosity when it is cold and give it a number like *10W*. (*W* stands for winter.)

Most cars today need multiple viscosity oil, which is made to be thin at low temperatures but thicker at high temperatures. This type of oil has a code such as *SAE 5W-30*. The *5W* tells you the viscosity when cold. The *30* tells you the viscosity when the engine reaches operating temperature (generally about 200 F).

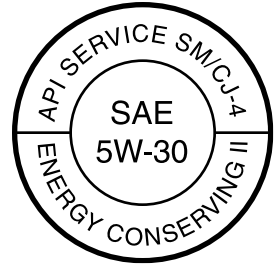

Look for the API symbol on the oil container to determine the oil's performance level and viscosity.

The lower the SAE number, the more easily the oil flows.

Checking and Adding Oil

Each vehicle's owner's manual states the type and amount of oil the vehicle needs and how often you should change the oil and filter. A standard interval is every three months or 3,000 miles; some auto manufacturers suggest longer intervals.

Between oil changes, you should check the oil level often. Pull out the *dipstick* (a long metal rod with a curved handle), wipe it with a clean, lint-free rag, put it in, then pull it out again. The level of oil in the crankcase will show on the dipstick. If the level is at or below the "ADD" mark, add more oil.



If you change oil yourself, you should dispose of the used oil properly. Put it in a leakproof container, label it, and take it to a recycling facility. Do the same with used oil filters.

Changing the Oil

It is best to have an experienced adult help you when you change your car's oil. Before you begin, check the owner's manual to determine the types and/or sizes you need of the following materials.

Use the recommended number of quarts and the type of engine oil suggested by the manufacturer in the car owner's manual. Keep an extra quart on hand to top off the oil if your regular maintenance shows that the oil level is low.

1 oil pan suitable for disposing of the used oil

Be sure the car is "cold" when doing an oil change. Otherwise, the oil will be too hot to handle. Make sure the pan is large enough to catch all of the oil from your vehicle.

Prepare the vehicle. Park it on a level surface, engage the parking brake, and turn off the engine. If you need to raise the vehicle, you will need ramps or a jack and jack stands made to be used for this type of auto maintenance work. Raise the front of the vehicle by having an adult drive it onto a ramp or by jacking it up and supporting it with jack stands properly in place. (Be sure you work under the supervision of your merit badge counselor or a knowledgeable adult and follow the manufacturer's instructions.)



Caution: Never get under a vehicle supported only by a jack! Jack stands or wheel chocks (if you are using a ramp) are recommended to help prevent wheels on the ground from rolling. Be sure to use the jack provided by the manufacturer only in the manner specified by that carmaker and in the owner's manual. The jack provided by the manufacturer is meant to be used only when changing a tire.

Step 1—Remove the oil fill cap and put it in a safe place.

Step 2—Slide under the engine and position the oil drain pan directly underneath the engine pan plug.

Step 3—Use a wrench to loosen, then remove, the drain plug. (Remember to keep the oil drain pan underneath!) Oil will begin to drain immediately.

Step 4—Slide out from under the car while the oil drains completely. The process takes several minutes, and you are safer out from under the vehicle than you would be underneath it.

Step 5—When the oil has completely stopped draining from the engine oil pan, return to your position under the car and replace the drain plug. Be sure to tighten the plug to prevent oil leaks when you add the new oil.

Step 6—Position the drain pan under the oil filter, then remove the filter by turning it counterclockwise. Carefully place the filter into the drain pan.

Step 7—Use a bit of new oil to coat the rubber gasket on the base of the new oil filter, then use your hands to screw the filter into place, about three-quarters of a turn after the gasket makes contact.

Step 8—Move the oil pan and filter out of the way. With an adult's assistance, reposition the jack under the car and jack the car back up so that you can remove the jack stands. Then slowly lower the car back to the ground. OR, if you used ramps, remove the chocks and have an adult roll the car back off of the ramps. Reset the parking brake.

Step 9—Add the recommended number of quarts of oil and replace the oil cap.

Step 10—Start the car and allow it to idle for about five minutes. The “check engine oil” light on the dash probably will remain lit until the new oil makes its way through the system.

Step 11—Check for leaks underneath the car. If oil is leaking onto the pavement, you will need to tighten the drain plug.

Step 12—Check the oil level. It should read “full.”



The Cooling System

Gasoline burns at temperatures as high as 4,500 degrees Fahrenheit, so a gas engine makes large amounts of heat. Only about 25 percent of this heat is used to create power. About 35 percent passes out of the exhaust system into the air, and 10 percent is lost to internal friction and lubrication.

The cooling system carries away the remaining 30 percent of heat. If the cooling system fails, engine oil evaporates, and parts can lock up or even melt, damaging or even destroying the engine.



How the Cooling System Works

A belt-driven water pump at the front of the engine circulates *coolant* (a mixture of water and antifreeze) through water passages inside the engine block and cylinder head. This transfers heat from the metal to the liquid coolant. The coolant then passes through tubes in the radiator.

Thin metal fins attached to the tubes give the tubes much more surface area, which helps speed the cooling process. The fins conduct heat away from the coolant and into the passing stream of air. When the vehicle is standing still or moving slowly, a fan blade helps pull air through the radiator.

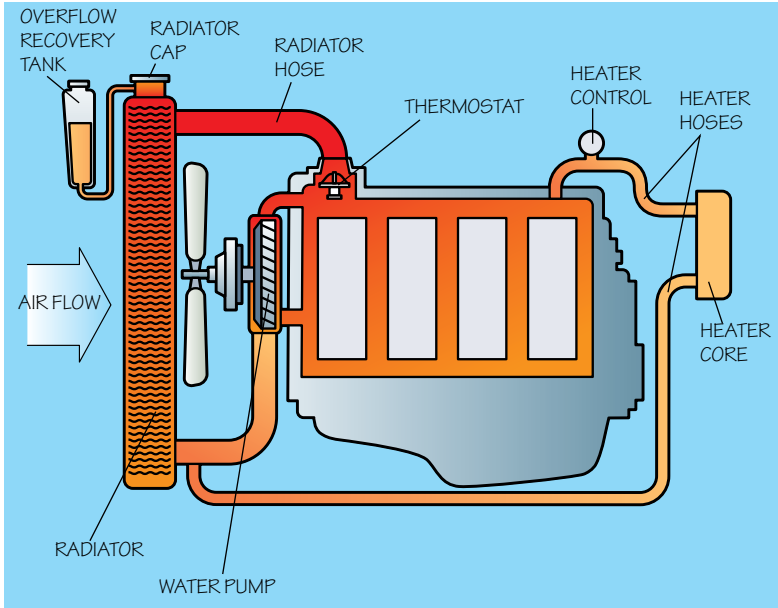

Cooling system components

Coolant Temperature Control

When you first start a vehicle, there is no need for cooling. The engine must come up to operating temperature as fast as possible to ensure maximum performance, good oil flow, and

in wintertime, heat for the passengers. When the engine is cold, a thermostat closes, blocking coolant flow through the radiator. Coolant can circulate only through the engine.

When the engine coolant temperature rises to about 195 degrees, the thermostat valve opens and coolant flows through it from the engine to the radiator.



Pressurized Radiator Cap

To provide efficient cooling, a special radiator cap pressurizes the system and increases the coolant's boiling point to more than 250 degrees Fahrenheit. *Never unscrew or remove the radiator cap when the engine is hot. The hot coolant can spray out and cause severe burns.*



It bears repeating: **Never** unscrew the radiator cap when the engine is hot.



Choosing the Right Type of Coolant

Make sure to follow the vehicle manufacturer's advice when choosing an engine coolant. There are three basic types of coolants in today's market:

IAT (inorganic acid technology). This type, dyed bright green, is commonly used in cars made before the late 1990s. An IAT coolant contains phosphate and silicate chemical compounds that help protect the cooling system from corrosion. The fluid should be flushed out of the vehicle's system roughly every two years or 30,000 miles.

OAT (organic acid technology). As the name suggests, this type does not offer phosphate or silicate corrosion inhibitors, but some brands include special additives to do that job. OAT coolants are dyed dark green and can last much longer than IAT brands, up to five years or 150,000 miles.

HOAT (hybrid organic acid technology). These coolants mix OAT with corrosion inhibitors and last the same length of time as OAT coolants. HOAT coolants contain 10 percent recycled antifreeze and are dyed orange; if no recycled antifreeze is used, the coolant is dyed yellow.

The best choice of coolant may also depend on the climate in which the vehicle is being driven. In northern areas with periods of extreme cold temperatures, an antifreeze mixture is recommended so the fluid will remain liquid and function properly throughout the year. In significantly warmer climates, a water-based coolant without freeze protection may be sufficient.

Most antifreezes are made with ethylene glycol, a type of alcohol made from ethane. Mixtures using propylene glycol, a compound made from propane, are also available and considerably less toxic to the environment.



Coolant

Manufacturers generally recommend an equal mixture of water and ethylene-glycol antifreeze. This coolant mixture offers good cooling during the summer and protects the engine down to about 35 degrees below zero Fahrenheit in the winter.

Some manufacturers now sell *prediluted* coolant. When you use this type of coolant, you should not add water.

Cooling System Maintenance

Coolant should be checked regularly and replaced about every 30,000 miles or two years, or up to five years in some newer vehicles. The system also might need to be flushed if there is too much dirt and rust in the coolant.

To check the car's coolant in most new cars, you need only to check the coolant level on the plastic coolant reservoir and, if necessary, add coolant there.

If your car does not have one of these reservoirs, you will need to remove the radiator cap to check the fluid—but only if the engine is cool. To remove the cap, wrap a cloth around the cap and slowly loosen it to the first stop. Step back and let the pressure release. Then, with the cloth still in place, press down and slowly turn the cap until it is free.

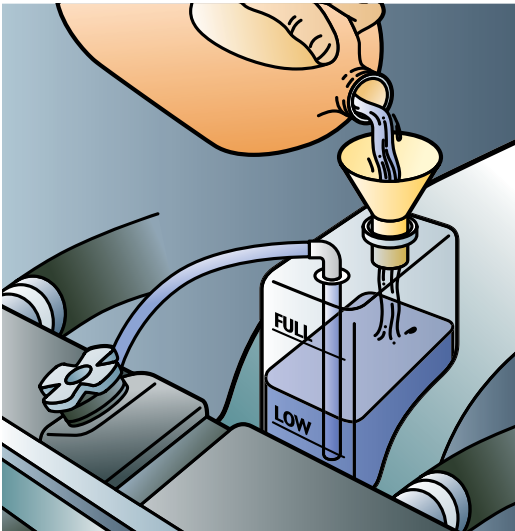

Coolant reservoir

Flushing and Replacing Coolant

Before you begin, let the engine cool completely. Here are the key steps in flushing and replacing coolant.

Step 1—Find the radiator drain plug and place a large pan underneath it. Remove the drain plug and let the coolant drain into the pan. (If the engine is cold, you can remove the radiator cap to speed up drainage.)

Step 2—When the coolant has drained completely, replace the drain plug and refill the radiator with tap water.

Step 3—Start the engine and let it reach operating temperature. Run the engine for a few minutes to make the water circulate through the engine. Then let the engine cool completely, and drain the radiator fluid into the pan again.

Step 4—Replace the drain plug, and refill the radiator with an equal mixture of distilled water and coolant.

Step 5—With the radiator cap off, start the engine. This will force air out of the system.

Step 6—Top off the coolant and replace the radiator cap.

Dispose of the old coolant in accordance with local laws. Never pour it on the ground.

Herbicides
Oil
Solvents
Pesticides
Antifreeze
Cleaners
Cooking Oil
Light Bulbs
Fertilizers
Batteries
Paint

Tip:

1. Keep chemicals in their original containers.
2. Place broken or leaking containers in a leak-proof container (glass for oil).
3. If a container has no label, please label the container with the contents.
4. Do NOT put chemicals in the vehicle – transport them to the ECC.
5. Once inside the ECC, open the trunk of the vehicle.
6. Remember: When transporting hazardous materials, use proper tie-down techniques.

Help Yourself!
 Seal sets aside in different places than...

Cost Center:
 The City of Fort Worth...
 To find out...
 817-252-...
 click on...
 For a...
 form...

What is the Environmental Collection Center (ECC)?
 It's a free, drive-through drop-off site for leftover household chemicals. The City of Fort Worth operates it as a safe way to dispose of hazardous chemicals that can pollute our water system. When possible, materials are recycled. Household chemicals can be dangerous to sanitation crews, which is why they are not picked up curbside. Pouring household hazardous waste into storm drains is illegal, storm drains lead directly to creeks, rivers and lakes.

Who Can Use the ECC?
 Residents of Fort Worth and some nearby cities can use it. Fort Worth residents must bring a recent water bill or driver's license to prove they live in Fort Worth. If you live outside Fort Worth, call 817-275-4227 or visit www.fortworth.gov/eng/em and click on Household Chemicals to find out if your city participates and whether you need a voucher before coming to the ECC.

What's Accepted

Acids	Fluorescent light bulbs
Aerated cans	Herbicides
Antifreeze	Mercury thermometers
Batteries (all kinds, including car batteries)	Motor oil & filters
Brake fluid	Paint, stain & thinners
Cleaning supplies	Pool strips
Cooking oil	Pesticides
Craft and hobby chemicals	Pharmaceuticals (old medicine)
Degreaser	Flammable liquids
Drain cleaner	Pool chemicals
Fertilizer	Solvents
	Transmission fluid

What's NOT Accepted

Ammonium	Fire works
Apparatus	PCB oil
Asbestos	Pesticide cylinders
Brush	Propane cylinders
Bulky waste	Radioactive material
Building materials	Smoke detectors
Butane	Syringes
Computers	Televisions
Electronics	Tires
Explosives	Trash

NO BUSINESS WASTE

FORT WORTH ENVIRONMENTAL MANAGEMENT

This publication is used with the permission of the City of Fort Worth, Texas.

Check with local authorities on the proper way and place to dispose of hazardous waste like used motor oil and antifreeze.

Inspecting Hoses and Belts

From time to time, inspect the hoses, clamps, and drive belts for wear or damage, and check drive-belt tension. If you do not have a tension gauge, push down on the belt halfway between the two pulleys. It should move about half an inch. If there is too much movement, the belt is loose. Adjust the proper drive belt bracket.

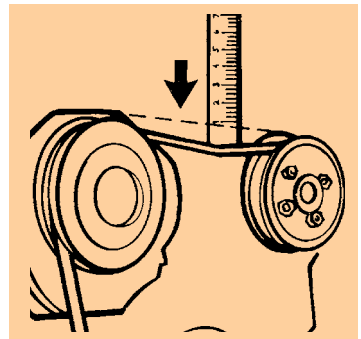

Checking drive belt tension



The Ignition and Electrical Systems

The engine gives a car most of its power, but electricity makes the car start, fires the spark plugs, and runs such features as the headlights and the sound system.

The ignition system uses electrical power to make a spark in the combustion chamber, which ignites the air-fuel mixture. The battery provides the power to start the engine. While the engine is running, the charging system keeps the battery charged. When the engine is off, the battery sends electricity to the lights, sound system, and other electrical systems.

The Ignition System

The ignition system creates the sparks that make the cylinders fire. The most important part of this system is the *spark plug* at the top of each cylinder, which has a gap in it. When there is enough electrical power (as much as 40,000 to 50,000 volts), electricity jumps this gap. This causes an arcing effect that makes the air-fuel mixture in the cylinder explode.



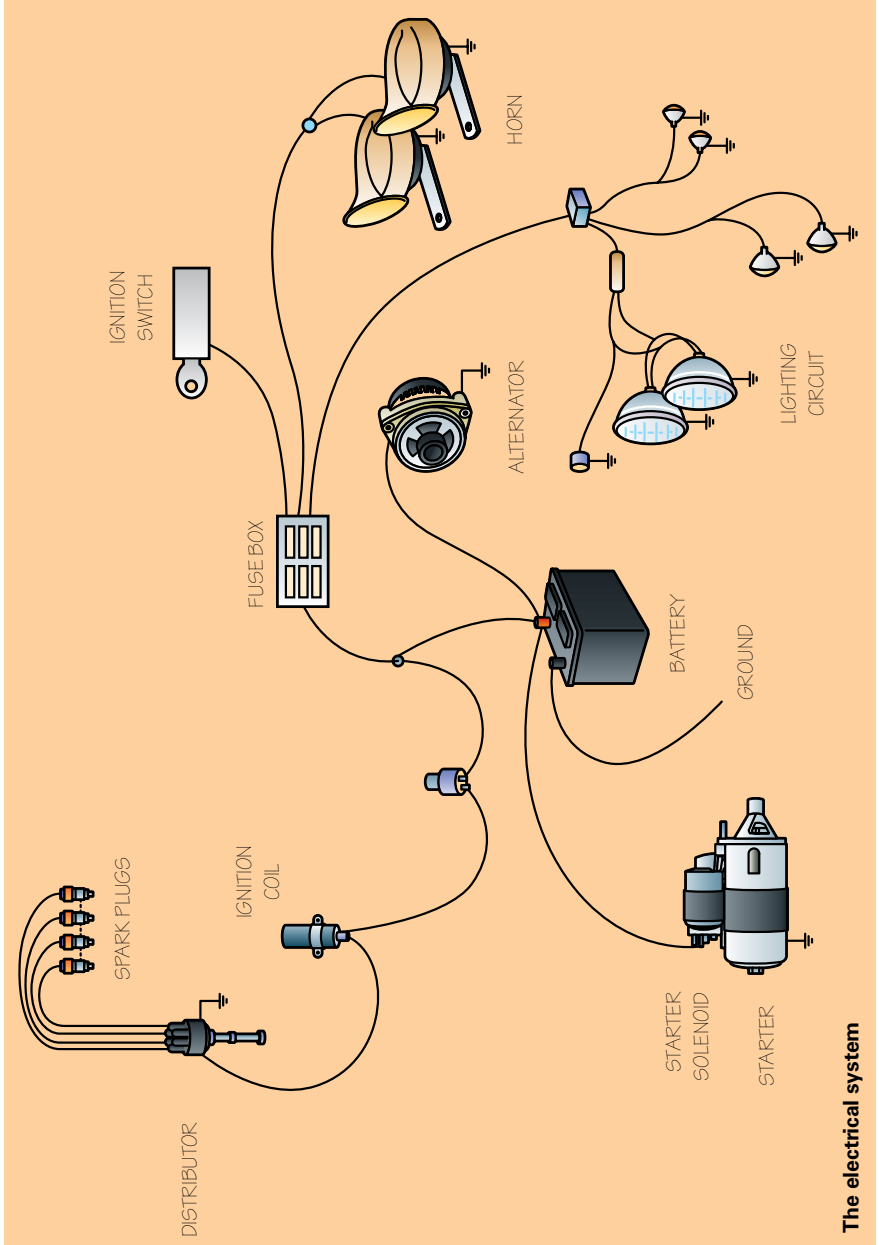

The electrical system

The Ignition Coil

Ignition coils transform 12 volts of electricity into 40,000 to 50,000 volts.

Making power jump over the spark plug gap takes 40,000 or more volts of electricity, but the battery supplies only 12 volts. The *ignition coil* is the device that boosts the voltage. It has an iron core surrounded by two sets of wire *windings*. Current flows through the primary windings and generates a magnetic field around the core. When the current stops flowing, the magnetic field collapses. This makes high-voltage current flow in the secondary windings.

Electronic Ignition

Most cars built since 1975 use some form of electric ignition to break the current flow in the ignition coil's primary windings. Solid-state electronics controlled by the engine control unit turn the current off and on as needed.

Spark Plugs

For most car owners today, changing the spark plugs in a vehicle has become a thing of the past. However, it is still a useful skill if you use anything with an internal combustion engine, like a lawn mower, dirt bike, or motorcycle.

A spark plug screws into a hole in each cylinder head. The center electrode (a metal tip that is a good conductor) carries electricity, while the side electrode is connected (*grounded*) to the engine. At the bottom of the spark plug, the electrodes are separated by a gap only a fraction of an inch wide. Sparks must jump over this gap.

Arcing can make the electrodes wear out so the gap between them widens. Waste from combustion can also build up. This is why you must replace spark plugs from time to time. Using a spark plug socket makes this task easy. Its rubber insert prevents damage to the ceramic part of the plug.

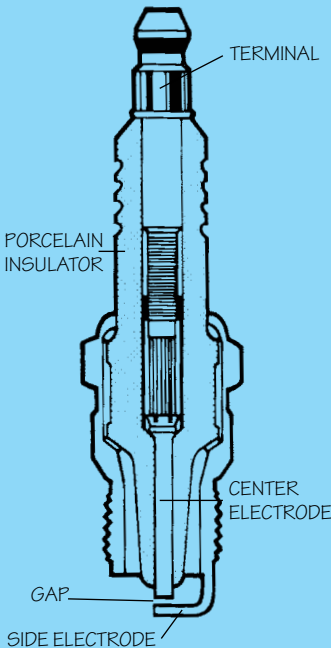

Spark plug construction

Changing a Spark Plug

Change spark plugs only when the engine is cold. It is a good idea to always replace spark plugs with the same make and model. Follow these steps to change a spark plug.

Step 1—Twist and pull the rubber boot, not the spark plug wire, from the spark plug.

Step 2—Clean around the spark plug with a shop rag or brush.

Step 3—Using a spark-plug socket on a socket wrench, remove the spark plug from the engine by turning the wrench counterclockwise. Using a feeler gauge, set the spark plug gap the vehicle's manufacturer has specified.

Step 4—Hand-tighten the new spark plug by turning it clockwise. Then, tighten it with the socket wrench using torque specifications of the product to avoid stripping threads.

Step 5—Firmly press or twist the boot in place.

When replacing multiple spark plugs, change only one plug at a time. This will reduce the risk that a wire will get on the wrong plug.



Engine Firing Order

Firing order is the sequence in which the spark plugs operate. Each cylinder has a number. On most inline engines, the cylinder in front is number 1. On V-6 and V-8 designs, one side uses even numbers (2, 4, 6, etc.) and the other side uses odd numbers (1, 3, 5, etc.). The firing order reduces unwanted vibration. The illustration shows typical firing orders.

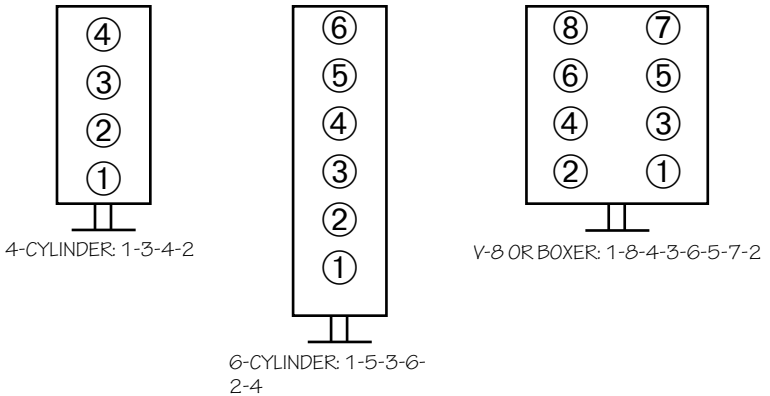

Typical firing orders

Other Electrical Systems

Cars and trucks use lots of electrical devices. Many of them work only if the ignition switch is on. We will look at some of the most important electrical systems.

The Starting System

The *starter* is an electric motor with gears at one end. When you turn the key in the ignition it closes a *solenoid relay*, a circuit that lets electricity flow to the starter and makes its gears *engage* (connect with) the flywheel gears. Once the engine starts, the ignition switch lets go, which opens the circuit and disengages the gears.

The Charging System

The charging system uses an *alternator* to convert rotary motion (driven by belts from the engine) into electricity, which recharges the battery and drives various electrical components. A voltage regulator controls the amount of recharging.

The Lighting System

The lighting system includes the interior overhead lights, instrument lights, headlights, taillights, turn signals, warning lights, hazard lights, and exterior lights. When you open a car door, plunger-type switches close a circuit to the interior lights and make them go on. When you apply the brakes, a switch under the pedal closes a circuit to the brake light bulbs so they light up.



Accessories

Wires connect the battery to many other accessories, including the sound system, heating and cooling systems, and (if the car has them) power windows and power seats. All have separate switches. In some cases (such as the sound system and the heating and cooling systems), you must also turn the ignition switch on to close the circuit to the battery.

A solenoid is a coil of wire that wraps around a metal core. Electricity magnetizes the coil and makes the core move, opening or closing an electrical circuit.

To ground the cable, connect it to the ground or to another conducting body, such as a shiny, unpainted metal part of the car. Try clamping the cable to part of the car's frame.

The Battery

Like the batteries in a flashlight, a car battery stores electricity. It has two *terminals*, or posts. One is marked negative (-) and the other is marked positive (+). A cable connects the negative terminal to the engine block, which acts as a ground. A second cable connects the positive terminal to the car's many electrical devices. Current flows out of the positive terminal to the electrical parts. It returns through the ground to the negative terminal.

So how does a battery store electricity? Each of its six cells has a lead plate and a lead-dioxide plate, both of which are surrounded by *sulfuric acid*. Chemical reactions between the metal plates and the acid make about 2 volts of electricity. Because a car battery has six cells, it generates 12 volts of electricity.

Battery Maintenance



Because most car batteries are sealed, they never need water added to them. If your battery is of the type that needs water added to its cells, check it regularly. Unscrew the six round caps on top and check the fluid level in each cell. If the fluid level is below the fill mark, add water to fill.

About once a year, clean the battery terminals with a wire brush and clean the top with a solution of water and baking soda. Check the cables to make sure they are tight on the terminals.

Unlike flashlight batteries, lead-acid batteries can be recharged by forcing electricity back into the positive terminal. This changes electrical energy back into chemical energy.

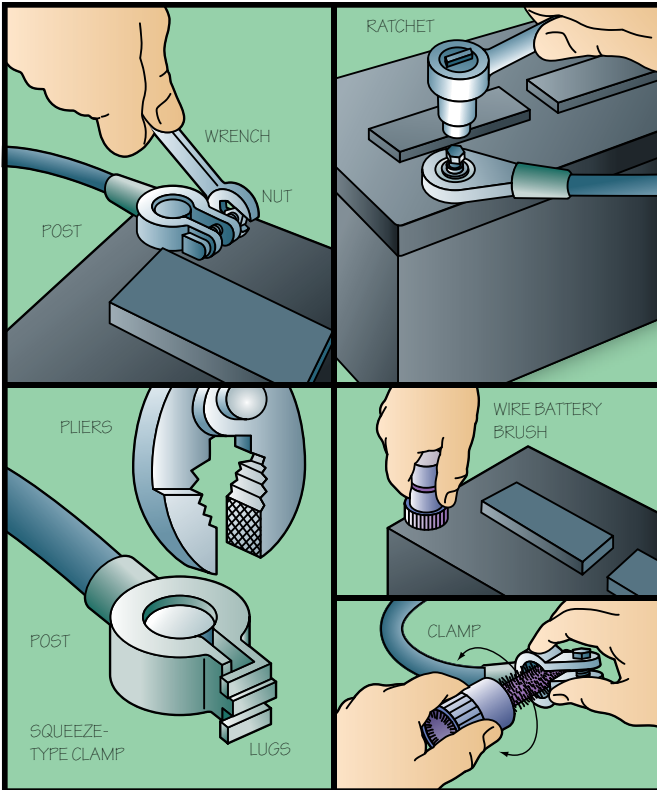

Battery connections must be clean and tight.



Red clamps must always be connected to positive (+) terminals, and black clamps to negative (-) terminals. Reversing this could cause significant component damage. For safety, the negative cable is always first off during removal and last on during installation.



Always wear safety glasses when working around the battery. Placing a fender protector on the vehicle will protect the paint in the event of an acid spill.

Using Jumper Cables to Start a Car

If you hear a clicking sound when you try to start your engine, or the engine groans but does not start, the battery may be discharged. Often, you can use jumper cables and a second car battery to start the car. Here are the steps to jump-start a car.

Caution: Follow these instructions carefully to help avoid generating sparks; these can be a fire hazard because there are combustible gases around batteries. Wear gloves and eye protection throughout the process.

Step 1—Park the second car so the two batteries are close together but the cars are not touching. Put both cars in park and turn off accessories.

Step 2—Hold the jumper cables so the clamps are not touching each other or anything in either engine compartment.

Step 3—Clamp one end of the red cable to the positive (+) terminal of the dead battery. Clamp the other end of the red cable to the positive (+) terminal of the good battery.

Step 4—Clamp one end of the black cable to the negative (-) terminal of the good battery. Clamp the other end of the black cable to an unpainted metal surface of the dead engine, such as a bolt or bracket. Do not clamp it to the negative terminal. Use a surface that is as far away from the battery as possible.

Step 5—Double-check all connections and then start the second car. Let it idle for a few minutes. It is ok to start the second car before Step 2.

Step 6—Start the dead car. Let both cars idle for a few minutes, and then remove the jumper cables in the reverse of the order in which you connected them. As before, do not let them touch each other or any other surfaces.

Step 7—The alternator should recharge the dead battery after 30 minutes or so of driving. However, you may need to recharge it with a battery charger to avoid overworking the alternator.

Self-contained, rechargeable power boosters also can jump-start a vehicle—with less of a safety risk. When you use one of these units, take the same precautions, wearing eye protection and gloves, and working slowly and carefully.

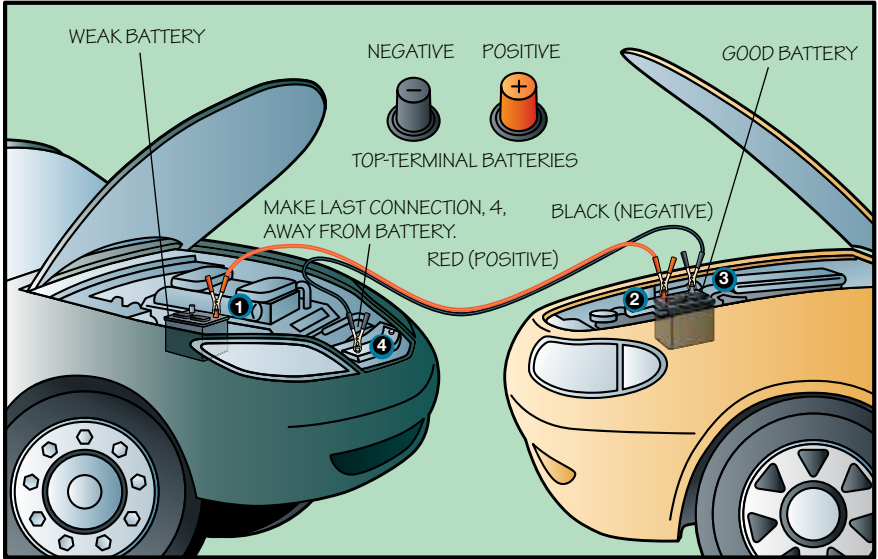

Correct jumper cable connections



Checking a Vehicle's Lights

Check the owner's manual to learn how to turn on the lights for your particular vehicle.

Light bulbs in a car burn out just like the ones at home, and you must replace them. You should check all the lights on your vehicle from time to time to make sure they work properly.

Turn on the headlights, which will simultaneously light the instrument lights and taillights. Check to see that each bulb is glowing. Engage the high beams on the headlights and make sure that both headlights' high beams work. Have a friend step on the brake pedal while you check to see that the brake lights work. Have your friend start the engine, apply the brakes, and shift into reverse while you check the backup lights. Return the car to park and turn off then engine, then turn on the hazard light switch and turn indicator. Make sure all the lights flash.



Check the owner's manual for instructions on how to reach and replace the headlamps.



Never stand in front of or behind a car while the engine is on.





Typical fuse panel

Replacing Electrical Fuses

Fuses protect vehicle electrical systems. A fuse is the weak link in an electrical circuit. When too much current is flowing, the fuse “blows,” or cuts off power to protect other components from damage.

The fuse panel usually is located under the instrument panel, to the left of the steering wheel, but it might be in the glove box or even in the trunk. Check the owner’s manual for the location of the fuse panel on your vehicle.

Labels next to fuses or on the fuse panel’s cover tell you which circuit goes with each fuse. If an electrical system or accessory does not work, find the right fuse, pull it out, and see if the silvery piece of metal inside is broken and burned, which indicates that the fuse is blown. Replace the fuse with a new one of the same type, either cartridge or blade, and the same *amperage* rating—typically 10, 15, 20, or 25 amps.



The Computer and Emission Control Systems

Cars today include 50 or more *microprocessors*—tiny computers that control everything from the fuel-air ratio to the airbags. They help reduce tailpipe emissions and make it easier for technicians to find engine problems.

Before there were computers, engine systems worked mechanically using linkages, levers, springs, and vacuum devices. Even car radios had mechanical tuners. Electronic control is faster, more precise, and more reliable.

The Electronic Control Unit

The electronic brain of the car is the engine control unit (ECU). A little smaller than a merit badge pamphlet and about 2 inches thick, the ECU typically is located beneath the instrument panel. A large connector with up to 60 circuits connects it to the car's wiring harness.

The ECU receives input from dozens of sensors that monitor various engine conditions, including temperature, speed, and engine vacuum. Based on this information, the ECU decides how to adjust the engine and sends an electrical signal to an *actuator*, a device that converts the electrical signal into mechanical action. For example, the actuator may tell a fuel injector to spray fuel into the engine.

On-Board Diagnostics

The on-board diagnostics (OBD) system helps technicians find problems with the engine and other systems. When the ECU data indicates a problem with the engine, it generates a *fault code*, which is like an abbreviated error message. A technician can look at this code to help pinpoint what is wrong.

Since the 1996 model year, manufacturers have used a set of fault codes called the *OBD-II specification*. A typical OBD-II fault code would be P0171. Here's what that code tells the technician:

- **P** stands for *powertrain*.
- **0** means it is a generic code. (This digit is always either 0 or 1; 1 means the fault code is specific to the manufacturer.)
- **1** means it is related to the emission management system.
- **71** tells you the particular problem. In this case, the system is running too lean on bank 1 (the side of the engine with cylinder No. 1).

Emission Control Systems

Almost every engine system has something to do with emission control. However, most car-related pollution comes from three sources: exhaust gases, evaporation, and crankcase gases.

Exhaust Gases

Exhaust gases are the result of fuel combustion and are expelled through the tailpipe. The catalytic converter controls these gases, using chemical elements like platinum, palladium, and rhodium to turn nitrogen oxides, carbon monoxide, and *carcinogenic* (cancer-causing) hydrocarbons into less harmful emissions like oxygen, carbon dioxide, and water.

The catalytic converter controls exhaust emissions.





Evaporative Emissions

Evaporative emissions occur when gasoline vapors *evaporate* (escape into the air in the form of a gas). To control these emissions, fuel-tank vapors pass through canisters of activated carbon before going into the engine to burn.

A spring-loaded door on your car's fuel-tank filler neck keeps evaporative emissions from escaping when the tank is open at the gas station. Since the 2000 model year, all cars sold in the United States have had an *onboard refueling vapor recovery system*, which captures vapors from the fuel tank during refueling.

Crankcase Gases

Crankcase gases, also known as *blow-by gases*, are gases that pass between the piston and cylinder wall and collect in the bottom of the engine. The *positive crankcase ventilation (PCV) valve* recycles these gases into the air cleaner or the intake manifold, where they can join the air-fuel mixture and reburn.

On most engines, the PCV valve is located where the hose enters the valve cover or intake manifold. Most manufacturers recommend that you inspect the PCV valve at 30,000-mile intervals. Pull the valve from the hose or grommet and shake it hard. If you cannot hear the internal parts rattle, the valve is plugged and should be replaced.



A gauge measures something, like speed. An indicator tells you whether a system is working properly.

The Dashboard

A vehicle's dashboard does more than keep passengers out of the engine compartment. It also tells the driver what is happening in the engine and other important systems. At a glance, the driver can find out how fast the car is moving, how far it has gone, how much fuel it has left, and whether there are problems with its electrical system, brakes, airbags, and other systems.

Most instrument panels are built into the dashboard, right behind the steering wheel. Some vehicles have center-mounted panels next to the steering wheel, while a few have head-up displays—like those in fighter jets—that project information onto the windshield. These displays let drivers check their speed or navigation directions while keeping their eyes on the road.

Instrument panel design varies by vehicle. Some use high-tech digital readouts, while others use simple needles and gauges. All instrument panels must have the basic set of gauges and indicators listed in the U.S. government's Federal Motor Vehicle Safety Standards. These standards also regulate the look and color of most indicators. Red is for big problems like overheating or brake failure. Yellow is for smaller problems like underinflated tires. Blue and green indicators, such as high-beam indicators, give status information only.



Many car manufacturers now offer additional features for safety and convenience such as in-dash navigation systems, parking assist systems, collision avoidance systems, and backup cameras.

Back in the days of horse-drawn carriages, a dashboard was an upturned board that kept mud from being dashed (splashed) onto a carriage's passengers.



To learn more about the instrument panel on the vehicle you are working on, you will need to be able to start the engine and have the owner's manual at hand. Sit in the driver's seat and read through the part of the owner's manual that describes the instrument panel. Find out what each gauge or indicator does and where it is.

If you are turning an ignition switch (some modern vehicles have proximity keys and push-button starting), a few indicators will come on for just a few seconds when you turn the switch to the "on" position. Therefore, you may have to move the key between the "on" and "off" position a few times (without starting the engine) during this exercise.

The next few sections describe many of a vehicle's gauges and indicators. Because automotive technology is always changing, you may see others on your vehicle.



Common Vehicle Gauges

The following gauges are those most often found in passenger vehicles. Put a check mark next to each item as you find it on your vehicle. If it is not there, write N/A.

- Speedometer.** This gauge shows how fast the vehicle is going in miles per hour (MPH) and kilometers per hour (KPH).
- Tachometer.** This gauge shows how fast the engine crankshaft is going in revolutions per minute (RPM).
- Fuel gauge.** This gauge shows about how much fuel is in the tank. (The amount it shows might not be exact.)
- Temperature gauge.** This gauge shows the temperature of the engine's coolant. The pointer should stay in the middle range during normal driving. In severe conditions, it may get closer to the red zone. If it moves into the red zone, pull over. Follow the owner's manual instructions to check the cooling system.
- Odometer.** This gauge shows how far the vehicle has been driven since it was built. (Note: It is illegal to disconnect, reset, or change the odometer reading.)
- Trip odometer.** This gauge shows how far the vehicle has been driven since you last reset it. This tool lets you figure out the distance between two points.

Other Critical System Gauges and Indicators

These gauges and indicators show you the status of several of the vehicle's important systems. Check them off as you identify them.

- Malfunction indicator lamp (MIL).** This indicator is often called the “check engine” light. It comes on if one of the engine's emissions control systems may have a problem. Even if the vehicle drives normally, the problem could reduce fuel economy and cause increased emissions.
- Charging system indicator.** This indicator tells you that the battery is not charging properly. If it comes on, take the vehicle to a qualified shop as soon as possible.
- Oil pressure gauge.** This gauge shows the engine oil pressure in pounds per square inch (PSI). The reading should stay near the midpoint.
- Low oil pressure indicator.** This indicator tells you that engine oil pressure is low. When this light comes on, turn off the engine as soon as you safely can and check the oil level. If it is low, add oil to the proper level. If the level is correct, there is a mechanical problem and you should have the vehicle towed.
- Low fuel indicator.** This light comes on to remind the driver to refuel soon. A chime may also sound.
- Brake indicator.** This light shows that the parking brake is set or that there is a problem with the braking system. If the parking brake is not set and the light comes on, the brake fluid level is probably low.
- ABS (antilock braking system) indicator.** This light tells you that there is a problem with the antilock braking system. The vehicle should still be able to brake even if the ABS does not work.

What other indicators or gauges do you see on your vehicle? List them below along with a brief description of each.

Other Gauges and Indicators

These gauges and indicators tell you about other vehicle systems. Check them off as you find them.

- Seatbelt reminder indicator.** This light reminds the driver and passengers to buckle up. On some vehicles, the light will remain on and a chime will sound every few seconds if the driver and front passenger do not fasten their seatbelts.
- Headlight high beams indicator.** This light tells you that the headlights are on the bright (*high-beam*) setting.
- Airbag indicator.** This light appears for a short time when you start the car. If the indicator stays on or comes on during driving, the vehicle should be taken in for service as soon as possible because one of the vehicle's airbag systems may have a problem.
- Door/trunk/tailgate open.** This light tells you that a door, the trunk, or the tailgate is not closed tightly.
- Tire pressure monitoring system indicator.** This light tells you that one or more tires are underinflated by 25 percent or more. It is a required indicator on all new vehicles, starting with the 2008 model year.

Buying a Car

Owning a car is a big part of the American dream. A car is also the first major purchase that many people make. To get the best car for the best price, you have to do your homework. The internet and printed pricing guides can help.



Finding and Buying a Car

Before you start actually looking at cars, think about what kind of car you would like to buy. Should it be a four-door or two-door sedan, a hatchback or minivan, a truck, or an SUV? Which features do you think are important? Which ones are less important to you? Perhaps you really want power steering or air-conditioning, but you do not think you need a sunroof or leather seats. How much money are you willing to spend? Keep in mind that you will also need enough money to pay for taxes, registration, insurance, gasoline, and maintenance.

Next, look at cars at local dealerships or from private sellers that fit your needs. Take cars you like for a test drive. With your parent or guardian's permission, visit websites like cars.com to read detailed reviews of the models you are considering.

Once you have found a car you really like, have a mechanic inspect it before you buy it. Many shops offer free courtesy checks. You can also use the vehicle identification number (VIN) to look up the individual vehicle's history at websites like carfax.com. If you find out that the car has been in a serious accident, keep shopping. You should also avoid a car whose title (the document that shows ownership) reflects that it was rebuilt; cars with "rebuilt" titles have typically been sold as salvage vehicles and then repaired.

Finally, bargain on a price for the car that is fair to both you and the seller. Unlike prices on most other products, car prices are usually negotiable. Printed price guides like the *Kelley Blue Book*, and the websites that go with them, suggest prices for thousands of used cars based on condition, options, mileage, and other factors. Usually these prices range from the trade-in price (what a car dealer would give you as a trade-in credit) to the retail price (what a car dealer would charge for the car). You should aim to pay a price in the middle.

New or Used?





When deciding whether to buy a new car or a used car, you have several factors to weigh. Rely on your common sense, and stick to your budget and what you need from your car. New cars offer peace of mind in that they should not require as much maintenance as soon as a used car would, and a new car most likely would be covered under a manufacturer's warranty for a few years. While they might not appear as appealing as a new car, used cars can be just as reliable—and a great deal less costly. Many used-car programs today offer vehicles that have been through an intensive inspection process and are guaranteed to be in good shape. And depending on the age of the car, it might still be covered under the manufacturer's warranty. Ultimately, the choice is up to you.

Kelley Blue Book The Trusted ResourceSM

Home | Car Values | Cars for Sale | Car Reviews | Awards & Top 10s

Home > Research & Explore > Compare Vehicles > Compare Side-by-Side

Compare Side-by-Side

Vehicle 1	Vehicle 2	Vehicle 3	Vehicle 4
 New 2020 Honda Accord Select a Trim 3-door EX 4-Cyl, I-VTEC	 New 2020 Hyundai Tucson Select a Trim Eco 4-Cyl, Turbocharg.	 New 2020 Nissan Altima Select a Trim 2.5 4-Cyl, 2.5 L	 New 2020 Ford Focus Select a Trim Sedan Titanium 4-Cyl.

Overview & Pricing | Photo Gallery | Features | Technical Specs | Safety | Reviews & Ratings

NEXT STEPS: Configure and get Fair Purchase PriceSM or Blue BookSM ValueSM

Prizing	Now: Base Model	Now: Base Model	Now: Base Model	Now: Base Model
Retail Price	Suggested Retail \$24,495-00 What should I pay?	Suggested Retail \$26,445-00 What should I pay?	Suggested Retail \$22,335-00 What should I pay?	Suggested Retail \$24,100-00 What should I pay?
New Car Incentives¹	Customer Incentive	Customer Incentive	Customer Incentive	Customer Incentive
Estimated Payments	\$186 /mo @ 1.99%* APR for 60 months Click for details	\$164 /mo @ 1.99%* APR for 60 months Click for details	\$109 /mo @ 1.99%* APR for 60 months Click for details	\$173 /mo @ 1.99%* APR for 60 months Click for details

Quick Facts

Fuel Economy	City 26/Hwy 35/Comb 30 MPG	City 25/Hwy 31/Comb 27 MPG	City 27/Hwy 39/Comb 31 MPG	City 26/Hwy 38/Comb 30 MPG
Engine	4-Cyl, I-VTEC, 2.4 Liter	4-Cyl, Turbocharged, 1.6 Liter	4-Cyl, 2.5 Liter	4-Cyl, Flex Fuel, 2.0 Liter
Transmission	Automatic, CVT w/Sport Mode	Automatic, 7-Spd EcoShift Dual Clutch w/ShiftTronic	Automatic, Xtronic CVT	Automatic, 6-Spd PowerShift w/SelectShift
Drivetrain	FWD	AWD	FWD	FWD
Max Seating Capacity	5	5	5	5
Doors	2	4	4	4
EPA Class	Midsize Cars	Small Sport Utility Vehicles	Midsize Cars	Compact Cars
Body Style	Coupe	Sport Utility	Sedan	Sedan
Country of Assembly	United States	Korea	United States	United States
Country of Origin	Japan	Korea	Japan	United States
Warranty				

Price guides are available online for both new and used cars, allowing you to compare before you ever begin your search in person.

Buying Insurance

The law says you must have liability insurance before operating a motor vehicle. Other types of insurance are not required by law but are a good idea to have. Here are some common kinds of insurance coverage.

- **Liability.** Pays the other person when you hurt them or damage their property
- **Collision.** Pays for repairs to your vehicle when you cause an accident
- **Comprehensive.** Pays for damage to your vehicle that was not caused by an accident, like damage caused by vandalism or a fire
- **Medical.** Pays medical expenses for you and your passengers after an accident
- **Uninsured/underinsured motorist.** Protects you if you are hit by someone who does not have auto insurance or does not have enough to pay for the damage caused
- **Towing.** Pays for towing if your car breaks down
- **Rental car.** Pays for a rental car for you to drive while your car is being repaired after an accident

The cost of insurance will vary depending on many factors, including your age, where you live, your driving record, and the type of car you are insuring. The Insurance Institute for Highway Safety estimates that insurance makes up 11 percent of the cost of owning a car over five years, so be sure to first check with your insurer on the costs of insuring the make and model of the car before you buy.

Calculating Annual Totals to Produce Approximate Cost Per Mile

Expenses	New Car	Used Car	New or Used Car
Operating Costs			
Cost of gas per 10,000 miles driven			
(Cost per gallon of gas ÷ miles per gallon X 10,000)			
Maintenance			
Oil changes			
Air, fuel filters			
Tune-ups			
Other			
Tires			
Rotation and balance			
Wheel alignment			
Ownership Costs			
Insurance (Basic liability, collision, comprehensive, towing, rental car)			
License, registration, taxes			
Miscellaneous Costs			
Car washes, cleaning supplies			
Accessories			
Total Driving Costs (Add all rows)			
Divide total driving costs by total miles driven			
Yearly Cost Per Mile			

Note: If you will be financing your car, the monthly payment should also be figured in under ownership costs.





Careers in Automotive Maintenance

The automobile was once a simple piece of machinery. Today, it is a sophisticated mode of transportation. This change shows in what we call people who take care of cars. Fifty years ago, they were called *mechanics*. Today we call them *technicians*. To work on today's vehicles, knowing how to use wrenches and hand tools is not near enough. Technicians also need to know how to work with technologies like the engine control unit and on-board diagnostics.

Position Descriptions

Automotive service has two major divisions: *mechanical repairs*, which includes diagnosing and fixing vehicle systems, and *body repairs*, which includes repairing and painting sheet metal and other body materials.

Mechanical Repair Positions

There are four main kinds of mechanical repair positions.

- *Apprentice* is an entry-level position. Apprentices perform minor repairs and help experienced technicians.
- *General technician* is the most common position. These technicians can perform almost any automotive service task.
- *Specialty technicians* spend most of their time working in one area, such as air conditioning or automatic transmissions. They usually need extra training and experience.
- *Diagnostic technicians* have advanced training on how to work with computer systems and electronic components. They find the cause of problems. They often work on "problem vehicles" that other technicians cannot repair.

Body Repair Positions

Body shops fix exterior damage to vehicles. There are three basic positions. Duties may overlap, especially in a small shop.

- *Estimators* inspect a vehicle to determine the time, materials required, and cost to make a repair. The *estimate* forms the basis of the price the shop quotes to the customer for the repairs needed.
- *Collision repair technicians* use hammers, frame machines, and many other tools to put damaged fenders, doors, frames, and body panels back to like-new condition.
- *Painters* mix paint to match a vehicle's color, apply primer sealers and surfacers to protect the surfaces from corrosion before applying the paint and clear coat, and refinish the surface to remove all signs of the repair.

Other Automotive Maintenance Positions

Large service organizations like dealerships employ a variety of other people. They include service advisers, who greet customers and prepare repair orders; service managers, who run the service department; parts managers, who are in charge of selling replacement parts; and parts counter workers, who sell parts to customers and fill requests from the service department.

Automotive service is exciting, challenging, and important work. No two days, and no two vehicles, are just the same. As cars become even more complex, the opportunities will keep growing for people who want to put their hands—and their brains—to work under the hood.

Technician Certification

Service organizations want to make sure they have the best possible technicians working in their garages. Car manufacturers offer training programs for technicians who fix the cars they make. In addition, many technicians receive certification from the National Institute for Automotive Service Excellence. This group offers certification in specific areas (brakes, engine repair, etc.) that is good for five years. ASE certification can make the difference when a would-be technician is applying for a position.



Automotive Maintenance Resources

Scouting Literature

Aviation, Electronics, Engineering, Inventing, Model Design and Building, Space Exploration, Traffic Safety, Truck Transportation, and Welding merit badge pamphlets

With your parent or guardian's permission, visit Scouting America's official retail site, scoutshop.org, for a complete list of merit badge pamphlets and other helpful Scouting materials and supplies.

Books

- Brand, Paul. *How to Repair Your Car (Motorbooks Workshop)*. Motorbooks, 2006.
- Dinkel, John. *Road & Track Illustrated Automotive Dictionary*. Bentley, 2000.
- Editors of Popular Mechanics. *Popular Mechanics Complete Car Care Manual*, Hearst, 2008.
- Gray, Michael E., and Linda E. Gray. *Auto Upkeep: Basic Car Care, Maintenance, and Repair*, 3rd ed. Rolling Hills Publishing, 2012.

Jackson, Mary. *Car Smarts: An Easy-to-Use Guide to Understanding Your Car and Communicating With Your Mechanic*. Avalon Travel Publishing, 1998.

Kennedy, Michael. *Career Opportunities in the Automotive Industry*. Facts on File, 2005.

Krebs, Michelle. *Careers Without College: Cars*. Peterson's, 1999.

Newton, Tom. *How Cars Work*. Black Apple Press, 1999.

Ramsey, Dan. *The Complete Idiot's Guide to Car Care and Repair*. Alpha Books, 2003.

Sclar, Deanna. *Auto Repair for Dummies*. IDG Books Worldwide, 2008.

Weber, Robert M. *Opportunities in Automotive Service Careers*. McGraw-Hill, 2001.

Organizations and Websites

Cars.com
cars.com

Edmunds
Telephone: 855-782-4711
edmunds.com

Insurance Institute for Highway Safety

Telephone: 703-247-1500

iihs.org

Kelley Blue Book

kbb.com

NADA Guides

nada.org/nada/consumer-vehicle-values

National Highway Traffic Safety**Administration**

nhtsa.gov

National Institute for Automotive Service Excellence

ase.com

Acknowledgments

Scouting America is grateful to Bob Rodriquez, Dan Baumhardt, and several members of the ASE test development staff for their assistance with this *Automotive Maintenance* merit badge pamphlet.

Thanks to the following for their assistance with past pamphlets: George Arrants, Automotive Youth Educational Systems Inc.; Matt Brown, American Honda Motor Co.; Charles Klasman, BMW of North America; Robert Slovey, General Motors Corp.; Joe Van Bodegon, Mercedes-Benz USA; Chris Mason, Raytheon Co.; and Robin Ferguson, University of Missouri.

Scouting America is grateful to the Birdville Independent School District and the BISD's Career and Technology department for allowing us to use their Shannon Center facility in Haltom City, Texas, for a photo shoot. In particular, thanks to Olin Harrington, an automotive technology instructor there, for his assistance with photography. We are

also thankful for the generosity of BP Lubricants/Quaker State, which provided supplies for a photo shoot.

Scouting America is grateful to the men and women serving on the National Merit Badge Subcommittee for the improvements made in updating this pamphlet.

Photo and Illustration Credits

Chrysler LLC/Dodge, courtesy—
page 63 (*car*)

Howstuffworks.com, courtesy—page 31

Library of Congress Prints and
Photographs Division, courtesy—
page 10

Mercedes-Benz USA, courtesy—page 73

National Highway Traffic Safety
Administration—page 21 (*Child Car
Safety logo*)

Snap-on Inc., courtesy—page 12

Texas Department of Motor Vehicles,
courtesy—page 19

Wikipedia.org, courtesy—pages 22,
27 (*combustion chamber*), 28
(*inline-4*), 41, and 64 (*coolant*)

All other photos and illustrations not mentioned above are the property of or are protected by Scouting America.

John McDearmon—all illustrations on
pages 20–21, 27 (*pistons, bicycle*),
28, 29 (*four-stroke cycle*), 30, 32, 36,
36, 38 (*treads and wheels, wheel
design*), 39 (*tire design, wear
indicator*), 41, 42, 43 (*front and
side views*), 45 (*tire wear patterns,
alignment*), 46, 50, 51 (*air-fuel
ratios, pressure*), 53, 56, 58, 63,
65, 67, 69, 70, 75, and 77

Get ideas
for your next
merit badge
adventure in
every issue
of *Scout Life*
magazine.



Subscribe today at go.scoutlife.org/subscribe
Use promo code **SLMBP15** to get a special
print + digital bundle offer priced just for Scouts!

